



September 2008

Human Terrain System

Human Terrain Team Handbook



U.S. Unclassified



**Human Terrain System
731 McClellan Ave.
Fort Leavenworth, KS
66027**



TABLE OF CONTENTS

I. INTRODUCTION	2
II. OVERVIEW	4
III. ORGANIZATION AND STRUCTURE	11
IV. METHODOLOGY	49
APPENDIX A - BEST PRACTICES OF AN HTT	81
APPENDIX B - BRIEFING	91
APPENDIX C - SAMPLE RESEARCH PLAN	104
APPENDIX D - SAMPLE INTERVIEW QUESTIONS	113
APPENDIX E - EXAMPLE REPORT FORMATS	116
APPENDIX F - COMMANDER FEEDBACK	119

**AUTHOR – CPT NATHAN FINNEY
CPT, AR
HTS DOCTRINE DEVELOPMENT TEAM LEADER**

Chapter 1

Introduction

“Understanding the effect of operations as seen through the lens of the [local] culture and psyche is the foremost planning consideration for every operation.”- LTG Peter Chiarelli, Commanding General, Multi-National Corps-Iraq, 2006 - 2007

Human Terrain Teams (HTTs) are five- to nine-person teams deployed by the Human Terrain System (HTS) to support field commanders by filling their cultural knowledge gap in the current operating environment and providing cultural interpretations of events occurring within their area of operations. The team is composed of individuals with social science and operational backgrounds that are deployed with tactical and operational military units to assist in bringing knowledge about the local population into a coherent analytic framework and build relationships with the local power-brokers in order to provide advice and opportunities to Commanders and staffs in the field.

HTTs are regionally-focused, modular special staff that brings capabilities that exist outside of organic Battalion, BCT, and Division structure. They deploy as trained and organized teams, attached to USMC Regimental Combat Teams, Army Brigade Combat Teams, and Division, Corps, and Combined Joint Task Force, level HQs. Each team is recruited and trained for a specific region, then deployed and embedded with their supported unit. The HTTs are comprised of a mix of Soldiers and Department of the Army Contractors that provide a mix of senior military specialists and academicians with strong social sciences credentials. An HTT integrates into the unit staff, conducts unclassified open-source and field research, and provides operationally-relevant human terrain information in support of the planning, preparation, execution and assessment of operations.

A fundamental condition of irregular warfare and counter-insurgency operations is that the Commander and staff can no longer limit their focus to the traditional Mission, Enemy, Terrain and weather, friendly Troops and support available, and Time. The *local population* in the area of conflict must be considered as a distinct and critical aspect of the Commander’s assessment of the situation. This

was codified in Army doctrine with the publication of FM 3-0 in June 2007, with modification of METT-T to METT-TC, adding “Civil considerations,”

...the nature of full spectrum operations requires commanders to assess the impact of nonmilitary factors on operations. Because of this added complexity, civil considerations has been added to the familiar METT-T to form METT-TC. All commanders use METT-TC to start their visualization. Staff estimates may address individual elements of, and add to, the commander’s visualization.

In an irregular warfare environment “Commanders and planners require insight into cultures, perceptions, values, beliefs, interests, and decision-making processes of individuals and groups” and should be evaluated according to their “society, social structure, culture, language, power and authority, and interests.”¹

The human dimension is the very essence of irregular warfare environments. Understanding local cultural, political, social, economic, and religious factors is crucial to successful counterinsurgency and stability operations, and ultimately, to success in the war on terror. In stability operations and irregular warfare, the human aspect of the environment becomes central to mission success. Information on social groups and their interests, beliefs, leaders, and the drivers of individual and group behavior is needed to conduct effective counterinsurgency operations. The expertise for conducting research and analysis to provide valid and objective information on these topics are highly specialized in the social sciences. Social science research of a host nation’s population produces a knowledge base that is referred to as the Human Terrain, or “The element of the operational environment encompassing the cultural, sociological, political and economic factors of the local population.”²

This handbook is designed to provide a base of knowledge for future Human Terrain Team members to understand and utilize their capabilities, as well as learn from previous deployments of other team members in order to integrate them into their training and employing them when in the field.

¹ FM 3-24, December 2006

² Human Terrain System CONOP, July 2008.

Chapter 2

Overview

The Human Terrain Team Mission

Mission Statement - Conduct operationally-relevant, open-source social science research, and provide commanders and staffs at the BCT/RCT and Division levels with an embedded knowledge capability, to establish a coherent, analytic cultural framework for operational planning, decision-making, and assessment.

There are three key points to the Human Terrain Team mission statement. The first is *social science research*. HTT's are unique in that they embed social scientists who are expert at developing and executing field research. The HTT takes the unit's campaign plan and develops a research design that accounts for the commander's PIR and CCIR, as well as perceived gaps in the unit's cultural knowledge. This research design identifies the knowledge requirements that the team can then address through specific missions amongst the population. The research methods used to illicit this required human terrain information include classic anthropological and sociological methods such as semi-structured and open-ended interviews, polling and surveys, text analysis, and participant observation. Both qualitative and quantitative methodologies are used, based on the research required.

Second is making the gathered data *operationally-relevant*. The human terrain information gathered by the team through the execution of their research design is analyzed and collated by the team, but if it is not distributed and briefed in a relevant manner, it is worthless data. One of the key functions of the Team Leader and Research Manager is to take that data from the social science research and couch it in terms familiar to a military audience, making it not significantly time-consuming, and insure it is operationally-relevant to the unit's operations and problem-set.

Finally is creating an *analytic cultural framework for operational planning, decision-making and assessment*. The team must not only conduct relevant research and make it usable to the unit; they must also insure it is incorporated into the continuous planning processes

conducted by the commander and staff. Human terrain information is of no use to the unit unless it is integrated into the continuous planning and decision making processes. The team must be tied into all planning processes, including relevant working groups, assessment boards, etc. that can utilize human terrain data and socio-cultural awareness.

Sources of Human Terrain Information

There are many sources that team members can leverage in order to ascertain human terrain information within their area of operations and support unit planning. These sources provide a framework for analysis and are a result from the culmination of study from a



variety of sources and require assiduous persistence to maintain. A sound cultural, linguistic and historical understanding is the teams' foundation of understanding, but contemporary research and knowledge will place these understandings in their proper current context. There is a degree of latitude in how the team maintains their understanding of the human terrain, but the following are possible sources (by no means exhaustive) they can turn to in order to remain current in their regional and local situational awareness.

Field Research through Unit Patrols/Missions



Engaging the locals and observing their customs and habits personally is indispensable to collecting accurate data. There is some information that can only be collected by the team interacting in person with the local residents. The unit's patrols and missions into the operating

environment are a prime opportunity for the HTT to collect this information. Census type data that are relevant to the needs of the unit (unemployment, literacy, education, etc.) and local perceptions is information that can be very difficult to collect systematically in dangerous areas and could be collected while on these missions. Additionally, the team will find that they are able to collect a great deal of unintended information as they make observations while accompanying the unit in the area. Collecting data and information directly from the local residents will buttress the credibility of their analysis. Collecting data in this fashion will require that the team members be comfortable with interviewing techniques and the use of interpreters. Accompanying units on patrols will allow the HTA to know, realistically, what information the soldiers, interpreters, auxiliary personnel, etc. have access to in order to generate questions and avenues of exploitation for the unit themselves to pursue. Quite often soldiers find themselves idle, surrounded by local residents (some that know English), and not really sure how to take advantage of the opportunity because they don't have any specific direction. The HTT will be able to draft up a reasonable list of questions for the unit to focus their attention on rather than discussing superfluous information.

Local Unit Reports

The supported unit generates a variety of reports articulating current activity in all phases of the unit's operations: Intelligence updates, assessments, and traffic analyses; Human Intelligence (HUMINT) reports; Situation Reports (SITREPs) from the various branches (PSYOP, Civil Affairs, IQATF, etc.), the reports generated by the individual units, Red Team assessments, and region/conflict-specific reports (i.e. Sectarian Report, host nation law enforcement evaluation reports, etc.) detail aspects of the conflict that are relevant to the unit. Much of the unit's tasking will derive from the issues identified in these reports and the HTT benefits from being familiar with their contents to ask intelligent and informed questions when that tasking does come.

News Sources

News sources are an excellent way to stay abreast of local, regional, and international events, trends, and attitudes. There are a number of ways to acquire this information, from online news feeds to hard

copy subscriptions. There is a vast availability of news, and the HTT may choose to sample sources from a variety of ideologies, formats, languages, to achieve their objective. A compilation of news summaries is the most efficient means of assimilating a great deal of information in a limited time. If an item seems particularly pertinent to the HTT's Operational Environment (OE), they can devote more time to it. Some regions locally produce a compilation of salient regional news items from Arab media and translate them into English (i.e. *The Baghdad Mosquito*). These products provide a convenient means for the team to remain current and understand regional perceptions. When reviewing news items, team members should focus their attention on specific issues and events. It may be worthwhile to compile a list of significant issues relating to their OE and the region and find news items that deal specifically with those issues. Certainly, new issues will arise and previously significant issues will become obsolete, but as the team's time is limited in this regard, only those items that directly pertain should be attended to.

External Agency Reports

A number of research organizations, think tanks, NGOs and the U.S. government conduct analysis on topics of regional interest. These reports address a wide range of issues and are useful in considering all factors that may influence local and regional perceptions and behavior. Brookings, The Center for Strategic and International Studies, Parameters, RAND, The Small Wars Journal, Long War Journal, Foreign Policy, Strategic Studies Institute, Congressional Research Service, and the International Journal of Middle East Studies are a sample of some of the organizations that conduct this analysis. Many of the aforementioned organizations conduct analysis on issues spanning the globe, not just that pertinent to Iraq and Afghanistan. Several tiers of the American military in country also conduct on-site analysis, and much of this useful to the HTT.

Unit and External Agency Meetings

Meetings provide an interface between organizations that are not articulated or summarized in reports. This dialogue allows the team a glimpse at the unit's priorities and operational evolution. The HTT can use these opportunities to determine the kind of cultural analytic support the unit could benefit from. The units hold a variety of meetings that cover local governance, economics, security forces,

intelligence updates, non-lethal targeting, and information operations. General knowledge of current status of these aspects of the conflicts round out the team's situational awareness. Local meetings are also a useful source of situational awareness; teams may be able to accompany units to attend these meetings as the units themselves normally attend. Meetings addressing essential services, security, reconciliation, the repatriation of Internally Displaced Persons (IDPs), local governance meetings, and business expos can provide the HTT with an understanding from the perspective of the local population, facilitating the communication of this perspective in their analysis.

Scholarly Literature

The team's Social Scientist, through academic channels, may have access to sites that store scholarly literature. This resource provides regional assessments and analyses conducted by academic specialists. This resource can best be used for historical context and long-term research, as scholarly literature is not necessarily the most current information.

Debriefing/Interviews

The HTT will not be able to participate in every worthwhile patrol to gather the information they may need to support their research and it will be necessary to acquire that information from garrisoned units and individuals. The unit staff themselves have some of the information the HTT needs to answer their research questions. Many times these individuals have information they do not consider particularly valuable, or they never think to report because it is not individually relevant to anything. Gathered properly, and from the right people, this information paints a comprehensive picture of the operating environment.

Organic Resources

A variety of resources are available to the HTT within the unit they supports. The unit's branches, offices, and subordinate units are able to provide many answers to the questions the team need answered. These offices will have compiled historical data for their respective areas and frequently the team will need to go no further to collect the required information. Some of these attached or subordinate units

conduct patrols among the local population regularly and are able to escort team members or will have the information already. These resources include Civil Affairs (CA), Psychological Operations (PSYOP), Information Operations (IO), Embedded Provincial Reconstruction Teams (ePRT), the unit assisting the security forces in forensic matters, United States Agency for International Development (USAID), Military Training Teams (MTT), National Police Training/Transition Teams (NPTT), specialized branches (the Reconciliation Officer, the contracts officer, etc.), interpreters, and other specialized military and governmental offices in the region. Upon receipt of tasking, the HTT will determine which, if any, of these resources could be solicited to satisfy the tasking requirements.

Local Resources

The team will also have access to a number of local organizations, individuals, and offices from which they will be able to gather information. As American forces continue to engage the local population, individuals and organizations will step forward to facilitate their efforts. Individuals from government offices, businesses, law enforcement and military units, community organizations, contractors, etc. may be able to provide the HTT with their information collection. The nature of the relationships between American forces and the local population will differ from area to area and the team will need to assess these relationships prior to consideration of their use as a source of information.

Liaison with Subordinate Units

The HTT can establish extremely beneficial relationships with subordinate units. These units have intimate, localized knowledge of their respective areas, and this information is often required in broader assessments. Subordinate units tend to have greater need and more appreciation for the services an HTT can provide and will generally ask for assistance or information more frequently. As HTTs do not have their own transportation assets, these subordinate units are necessary for the HTT to travel off military bases. The team may want to take the opportunity to assess the cultural knowledge gaps and undeclared needs of the unit and offer their respective services. The subordinate units, as they spend a significant portion of their time among the local population, can benefit from the kind of cultural awareness training the HTT could provide. The more

exposure the unit has to the kind of information the team deems important in the field, the more willing and proficient they will become in collecting similar information, for the benefit of the team and for their own benefit.

The structure of the team reflects the unique nature of a Human Terrain Team and how they conduct research. Also, the way in which an HTT addresses and leverages the sources of human terrain information is based on the organization of the team and each team members' roles.



Chapter 3

Organization and Structure

The Human Terrain Team consists of five to nine military and civilian personnel. Each team will include at least one Team Leader, one Social Scientist, one Research Manager and two Human Terrain Analysts. A more robust team is preferred, due to operational constraints and the need for the team to both take part in the planning and decision making processes at the unit headquarters and push team members out among the population to gather human terrain information to feed that process. The optimum composition of the team would include at least one member of the team will speak the language of the area of operation, one member will be a subject-matter expert of the area, and one team member will be a female (to allow the team access to the 50% of the population frequently overlooked in military operations).

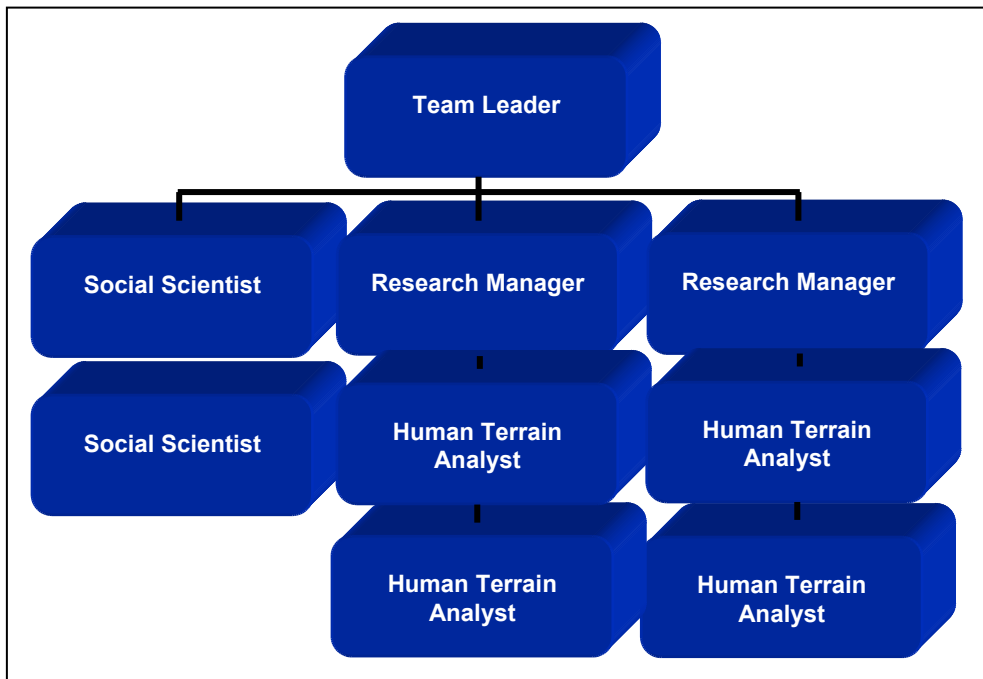

Figure 1 - Human Terrain Team Composition

Human Terrain Team Leader (TL)

The **Human Terrain Team Leader (TL)** is the commander’s principal human terrain advisor. They are responsible for focusing and supervising the team’s efforts based on the unit’s needs and integrating the collected information into military staff decision-making processes. At a minimum, the TL is an active duty or retired military officer with experience advising O-6/O-5 level commanders and has experience as a principal brigade or higher staff officer. The key task for a TL is to successfully integrate the HTT into the unit in an effective manner, becoming the commanders’ trusted advisor.

Team Leader Mission Essential Task List
Act as the commander’s Human Terrain Advisor.
Direct all aspects of HTT activities.
Serve as the primary interface between the HTT and the unit commander.
Insure the integration of Human Terrain into the planning processes.
Provide Human Terrain mapping and estimates to the commander before analysis.
Brief staff on pertinent cultural effects in the operating area.
Evaluate the Human Terrain against friendly & enemy courses of action.
Assist the BCT staff develop courses of action.
Represent the Human Terrain during unit planning.
Analyze orders to determine the commander’s intent in reference to the Human Terrain.
Approve and disseminate cultural products.
Monitor team Requests for Research.

Figure 2 - Team Leader METL

Social Scientist (SS)

Purpose: The Social Scientist is the unique member of a Human Terrain Team. They advise the commander and staff in all human terrain matters, and in particular the research methods required to collect that necessary information.

Functions: The SS manages ethnographic and social-science research, tying the team’s research design with the unit’s campaign design or operational concept and conducts ethnographic and social-

science analysis based on information gathered. The SS is an academically qualified (MA/PhD) cultural anthropologist, sociologist, international relations, political science, or economics expert.

Duties, Tasks, Responsibilities: The SS assists the team and unit to create a Common Operating Picture in relation to the human terrain. They achieve this by using pattern analysis to detect underlying cultural assumptions about the world and using cultural operational knowledge to keep units away from mistaken policy and practice and prevent the misapplication of force. They also support the commander's decision-making process by recommending options for the use of non-lethal effects to build trust, form partnerships and apply informed cultural knowledge to problem solving and building solutions, all while mapping the human terrain of the unit area of operations as well as the local populations.

Social Scientist Mission Essential Task List
Advise the HTT and staff on the cultural components of the environment.
Conduct & manage ethnographic research and analysis.
Participate in the planning processes.
Coordinate the Cultural Preparation of the Environment and Cultural Data Collection Activities.
Analyze cultural data.
Assist in the development of Information Operation Plans.
Identify cultural data and knowledge gaps.
Identify specified and implied cultural data requirements.
Analyze the operating area against cultural data.
Brief staff on pertinent cultural effects in the operating area.
Assess other characteristics of the battlefield (leaders, population, demographics, social, ethnic, and religion, etc).
Assess how the population sees the coalition and the adversary.
Assess the local population's interests and issues and what impact planned activities might have.
Identify areas of contention within society.
Provide local area interpretation of collected human terrain information.
Organize and manage focus groups with locals.

Figure 3 - Social Scientist METL

Research Manager (RM)

Purpose: The Research Manager is an integral part of any HTS team and is primarily responsible for knowledge management, information tracking, product dissemination, research strategy development and implementation, and developing data processing techniques and standards.

Functions: The RM works closely with the Social Scientist (SS) to develop, draft, explain, and implement a research design/strategy for a given mission or research project. This is critical for a successful mission and for good long-term continuity. The RM is also responsible for information tracking and storage (e.g. Requests for Research, final products, data files, field notes, etc.). This function allows for information flow by developing standard operating procedures for official requests for information, data processing, compilation, and dissemination. Additionally, the RM works to incorporate cultural knowledge into the Brigade (BDE) or Battalion (BN) Staff.

Duties, Tasks, Responsibilities: The Research Manager has many duties, tasks, and responsibilities that cover a broad range of categories. The RM participation in mission planning is to develop, document, and integrate the research strategy into the mission activities of the Human Terrain Team (HTT), and into that of the unit with which the team will embed. The research plan is not a single plan, but a series of contingencies. It is vital that contingency strategies be developed because the mission and the research opportunities can change without notice.

The RM is involved in working groups, which gives HTT a voice and allows for the potential to help shape future operations by aiding in the cultural preparation of the environment. The RM is involved in these working groups based on his or her background, as well as field experience. This assembly provides HTT an opportunity to interject cultural knowledge into future operations across all lines of operations. It also provides an opportunity to established focus to the working group. Small goals, with cultural influences in mind, can be established that will lead to the development of a sound foundation. The RM is not the only participant in these meetings, but is certainly in the position to provide valued input. Additionally, by attending these meetings the RM can get a better understanding of the BDE's

intent and potentially discover new areas that demand research action from the HTT.

The processing, storing, disseminating, and tracking of data are critical responsibilities of the RM. Developing standard operating procedures (SOP) for file management, data processing, dissemination, and tracking will allow the team to easily locate archived information. These SOPs will also allow for smoother intra-team operations through uniformity. Additionally, the means by which these are accomplished may differ amongst HTS organizations, but the importance is that each team has an SOP for these actions.

The RM should also design a means to capture team duties, roles, and activities for continuity purposes. All team members may not always be present, which means that each person will acquire extra duties from other team positions. Thus, continuity and transfer of knowledge is crucial to team success. Developing a Continuity Book is a duty that must be created as soon as possible.

The RM is also a potential collector of data from field research. This means that he or she must become very familiar with the research process and ethnographic interviewing. These skills are also vital in the development of the research strategy.

Research Manager Mission Essential Task List
Integrate human terrain collection plan with unit intelligence collection plan.
Maintain the Human Terrain component of the Common Operating Picture using the Cultural Preparation of the Environment.
Develop Human Terrain Information Requirements.
Secondary collector of human terrain data from coalition elements.
Collect and develop operationally-relevant information pertaining to human terrain.
Manage the team's requests for assistance from Subject Matter Experts, the Reach-back Research Center, and in-theater resources.
Analyze available sources of local cultural information.

Figure 4 - Research Manager METL

Human Terrain Analyst (HTA)

Purpose: The Human Terrain Analyst (HTA) is the Human Terrain Team's (HTT) cultural, regional, and in some cases, linguistic expert. Certain forbidding areas have been closed to direct social and cultural research for decades. The availability of social scientists with extensive field experience in these areas is presently lacking. Until a time when social science can be conducted more freely in regions where HTTs are deployed, the HTA supplements the Social Scientist's methodological expertise with a cultural and regional expertise. The HTA provides the HTT a resource of situational awareness and deeper understanding of how the culture influences the battle space. The HTA's primary function is data collection and the assessment and analysis of that data. This data and its subsequent analysis support the Social Scientist in satisfying the requirements of the unit they support.

Functions: Derived from unit and team-driven tasking, the HTA conducts open source research, interviews, debriefs, accompanies units on patrols, attends unit and local meetings, reads reports, engages with individuals of local influence, reviews scholarly literature, and any other means necessary to collect the information required to satisfy the tasking. The HTA assesses this information for relevance; conducts analysis to extract themes and draw conclusions; and compiles it in a form that is sensible and usable to the Social Scientist or unit. The HTA also advises and trains as called upon to do so.

Role within the HTT Structure

The HTA assumes much of the duties pertaining to data collection, initial assessment, and analysis. The tasking is communicated to the HTA through the Research Manager. There will be occasions where the HTA will need to collaborate with the Social Scientist, the Team Leader, and the Research Manager, but the HTA's day-to-day functions will require coordination with just the Research Manager. Team meetings will be the ideal vehicle for this collaboration and the HTA, Social Scientist, Team Leader, and Research Manager will work together to formulate research and data collection plans. Among the different positions on the HTT, the HTA will spend more time collecting data from the field, interacting with local residents, and gathering information from individuals within the supported unit.

Duties, Tasks, Responsibilities

The HTA plays a critical role in providing cultural and linguistic support to the research directed by the social scientist. This role will be balanced with tasks assigned directly to the HTT by the supported unit. The HTA will participate in collecting data, conducting research, analyzing the data, and drafting reports in support of unit Requests For Information (RFIs), the tasking of the social scientist, and self-initiated projects. The HTA may also be called upon to conduct training for, and advise, the supported unit. To maximize his/her efficacy as a resource of cultural and regional expertise, it is imperative that the HTA develop and sustain a sound situational awareness. This will allow the HTA to address a wide range of topics with confidence.

Situational Awareness

Situational awareness is the HTA's greatest asset. A current situational awareness provides a framework for analysis, and it results from the culmination of study from a variety of sources and requires assiduous persistence to maintain. A sound cultural, linguistic and historical understanding is the HTA's foundation of context, but a contemporary situational awareness will place these understandings in their proper modern context. There is a degree of latitude in how the HTA maintains his/her regional and situational awareness, but the following are possible sources, by no means exhaustive, the HTA could tap to remain current in their regional and situational awareness.

Analysis

Once the HTA has collected and compiled the information, it will need to be subject to analysis. Invariably, each HTA will apply their own individual style of analysis to the data, but, despite stylistic differences, the HTA should consistently consider certain guidelines. The following is not exhaustive, but are techniques to consider when applying the collected data to analysis.

Determine Relevance to Tasking

Once the data has been collected, the HTA will need to sort through it to determine what is directly relevant to the tasking. Analysis should be conducted on only that information which pertains directly to the request to retain its coherence and the requestor's attention. In the course of collecting data, the HTA is going to encounter a lot of interesting information, information that would benefit the unit in its mission and objectives. This information, if not directly relevant to the tasking, should be reserved for separate analyses. Individuals of the supported unit are already reading several operational reports each day and don't typically have time to read tangential additions to reports.

Interpreting Data

Once the relevant data has been isolated and compiled, the HTA will interpret the whole body of information according to certain guidelines. Some primary considerations in interpreting this information relate to the HTA's understanding of the request; its relevance within the broader context; national objectives; how the information fits in a "human terrain" frame; and how the information is relevant to the needs and success of the supported unit.

Understanding the Tasking

The HTA must ensure that he/she understands the intent behind the request. The HTA will normally rely on the Research Manager's efforts to narrow down and clarify the request so appropriate information is collected and conclusions are drawn. When interpreting data this must be a primary consideration in order to focus the analysis and conclusions on the desire of the requestor. This will also be a consideration when the HTA sifts through the data to determine if it is relevant to the tasking.

Situational Awareness

The HTA will have the advantage of placing the body of information within the broader context of his/her situational awareness. The "big picture" will often determine the true nature of localized phenomena and isolated events. The HTA will rely on the totality of information they have accumulated to determine the essence of the unit-level

snapshot they are analyzing.

Role and Objectives

The nature of the unit's involvement, role, and objectives will also color the HTA's conclusions and recommendations. The HTA's interpretation will vary according to the unit's role, whether that be counterinsurgency, nation building, occupation, peace keeping, kinetic operations, or a combination of these roles. As the American military's focus and training continue to revolve around kinetic operations, it is likely there are still units deploying that have no aspirations of filling a non-kinetic role; and most units don't understand the principles of their role (specifically with regard to counterinsurgency) even if they did want to conduct it. The more educated the HTA is in these non-kinetic roles, the more he/she will be able to provide useful analysis and recommendations.

Human Terrain

Human Terrain comprises the entire spectrum of society and culture. This should be the focus of the HTA's interpretation. In non-kinetic roles, the population is the primary battlefield, and the HTA will have considerable knowledge of this aspect. The HTA will need to determine how to win the support of the local population, how a certain COA will mitigate distrust between the local population, and will use their extensive familiarity with all aspects of the local society and culture to make those determinations.

"So What?"

Regardless of the task, the HTA should be continually asking himself/herself this question. The HTA needs to bear in mind how their analysis or conclusions are relevant to the needs and success of the unit, and how their analysis and conclusions satisfy the tasking. This is particularly important in self-initiated products, like assessments and media summaries.

Critical Thinking

Critical thinking is perhaps the most underrated aspect of analysis. Because it is difficult to look busy while thinking, those that do engage in this activity are seen as lazy or spacey. HTAs should be

given some latitude in how they conduct their activities. Focus should be on results rather than on how they are achieved. Thoughtful analysis requires deliberation, pondering, assessment, reflection, and speculation, activities that are discouraged in high paced environments.

Manipulating Data with Software Tools

In order to make sense of some of the data collected, and to minimize the amount of time the social scientist will need to interpret and incorporate the HTA's data, the HTA will need to use software applications to organize, collate, consolidate, and explain the data. Submitting the data and analysis in a form usable to the social scientist will facilitate its incorporation into a finished product and avoid confusion.

Procedural Employment of Methods and Strategies

Task Assignment and Coordination

Though tasking should normally be communicated through the Research Manager or the Team Leader (for the sake of order and simplicity, and to avoid any confusion) the HTA will often receive requests from individuals, units, or offices. When taking a request, the HTA should relay the tasking directly to the Research Manager for normal processing and clarification. Upon receipt of the request, the Research Manager will assign it to the HTA with the greatest aptitude to fulfill the requirements of the task. The Team Leader, Social Scientist, Research Manager, and appointed HTA will collaborate on a Research/Data Collection Plan. They will discuss the context of the request, the needs of the requestor, and clarify any ambiguities or logical gaps in the request. The Team Leader is uniquely positioned to translate military RFIs into tasks understood by those not familiar with Army protocol, and back into "military speak" for the requesting individual. The Social Scientist will understand the academic and methodological requirements to accomplish the task. The Research Manager will be the active liaison between the Social Scientist and the HTA to ensure the tasks are clearly understood, the data collection is relevant to the request and that the data collection is abiding by time requirements established by the requestor. The Research Manager will also act as liaison between the HTT and the requestor, clarifying the tasking if necessary, and

reporting the HTT's progress in completing the task. The Team Leader, Social Scientist, Research Manager, and appointed HTA will collaborate on a Research/Data Collection Plan. They will discuss the context of the request, the needs of the requestor, and clarify any ambiguities or logical gaps in the request.

Research/Data Collection Plan

From the tasking, the Social Scientist, Research Manager and HTA will devise a plan to collect all the data and conduct all the research necessary to fulfill the tasking. They will determine what data needs to be collected, how it is to be collected, the sources from which it will be collected, and what their limitations are in collecting the data they need. Depending on the experience of the HTA, a certain degree of autonomy will be granted the HTA to plan and conduct his/her research as deemed suitable to accomplish the task. However, the Social Scientist and Research Manager will generally have more expertise in how to manage research and collect data, and the HTA will normally defer to them in these matters. As the HTAs are typically the cultural and regional experts, they will occasionally need to assist the Research Manager in understanding the tasking from a cultural perspective. The team will determine if the request warrants the services of the RRC and the Research Manager will coordinate those requests for the team. Team collaboration is always the most propitious method for effective data collection, interpretation and analysis.

Individual Research Plan and Management

Subsequent to team collaboration to determine the HTA's tasking, the HTA will need to develop a more detailed individual research plan. The HTA will narrow the broader tasks down to manageable duties to facilitate collection. The HTA will list specific sources and methods to obtain the information that may include things such as individuals in the unit, attendance of specific unit meetings, Internet sites that contain pertinent information, local contacts, past RRC reports, drawing on previous experience, think tank reports, etc. The HTA will list every source that could satisfy his individual tasks. Tracking the sources accessed and tasks completed will allow the HTA to organize his/her work and communicate progress to the Research Manager.

Coordinating Transportation and Scheduling

The HTA's individual research plan may contain a number of local and unit sources and meetings. As HTT's don't have their own transportation assets, they will need to rely on other units for that accommodation. The HTA will be responsible for making these arrangements with the individual units. The HTA will also make arrangements personally, or through the respective units, to meet and communicate with local contacts. If debriefings and interviews are necessary to acquire the needed information, the HTA will need to schedule those with the appropriate individuals/units.

Coordination and Communication with RM

The HTA will need to be in constant communication with the Research Manager to ensure that the data being gathered corresponds to the tasking, that it is being gathered appropriately, that deadlines are being met, that any additional clarification of tasking is being communicated, that the HTA understands the nature and context of the tasking, and that it is being put in a form usable to the Social Scientist. This communication will allow the HTA to update the Research Manager on his/her progress and pass along any immediately pertinent information that may assist the unit or Social Scientist in their ongoing efforts.

Assessing Collected Data

Once the HTA has completed the collection of the required data and information, he/she will need to make a preliminary assessment of the data to determine the data's relevance according to his/her understanding of the tasking and situational awareness. Some information gathered will not directly pertain to the essence of the request and the HTA will need to recognize what should be excluded from inclusion in any assessment or analysis. The HTA will assemble the information and draft it into a report or form suitable to the needs of the Social Scientist or unit. This may require the manipulation of the data with software tools and applications. The HTA may want to include the software tools and applications that may facilitate assessment or analysis in his/her individual research plan. The HTA should carefully cite all sources used throughout the processes of collection and analysis, and include those sources with the finished product.

Standardized Format, Storage, and Dissemination of Products

For the purposes of continuity and organization, the format of all finished products should be standardized. A specific, logical naming convention should be applied to every report or team product. The finished product should be routed directly to the Research Manager, carbon copying the Team Leader and Social Scientist. The Research Manager will review the product and, in turn, forward it to the appropriate recipients. Once the product has been disseminated, the Research Manager will store it in a central repository that is accessible to the supported unit, other HTTs, and CONUS-based HTS personnel (RRC, administration, HTS trainees, etc.)

Advising and Training

There are some HTA functions that won't require drafted reports. Summaries of these activities should be recorded and submitted to the Team Leader in periodic activity reports or SITREPs. HTAs should detail the nature of all advising and training in these reports to record and track all HTT activity.

Vigilance

While on patrols, in meetings, in conversations, or conducting research, HTAs are going to encounter issues and information that he/she deems relevant or important to the supported unit. HTAs should discuss these matters with the team in meetings and present a proposal and research plan to the Research Manager and Social Scientist for review. If the Research Manager and Social Scientist deem the matter suitable for further exploitation, they will collaborate with the HTA on a revised research/data collection plan. These efforts should be encouraged or analogous pursuits recommended.

Human Terrain Analyst Mission Essential Task List
Primary collector of human terrain data from Coalition elements.
Develop a Human Terrain Collection Plan.
Develop Human Terrain Information Requirements.
Analyze unclassified cultural data.
Assist in the development of Information Operation Plans.
Identify cultural data and knowledge gaps.
Identify specified and implied cultural data requirements.

Analyze the operating area against cultural data.
Analyze available sources of local cultural information.
Assess other characteristics of the battlefield (leaders, population, demographics, social, ethnic, and religion, etc).
Develop Human Terrain Information Requirements.
Determine indicators and specific information requirements for supporting Commander's Critical Information Requirements, Decision Points, and Names Areas of Interest.

Figure 5 - Human Terrain Analyst METL

Roles and Responsibilities of a Human Terrain Team

The HTT has five key tasks to accomplish in regard to their supported unit. The first is to conduct a Cultural Preparation of the Environment (CPE). This continuous process is similar to the traditional Intelligence Preparation of the Battlefield (IPB), but instead of a focus on threats the CPE is focused on the socio-cultural information of the area of operations. The team, prior to and during the deployment, researches the area of operations. During the deployment CPE consists of collecting atmospheric, conducting polling, surveys and interviews of the local population. The longer the team is on the ground, the clearer the CPE will become. Fusing of the CPE and Commander's PIR, as well as HTT-identified cultural knowledge gaps in the unit's campaign plan, the team creates a Research Design. This research design will address those knowledge requirements and help the team coordinate their cultural research activities across the unit staff and maneuver units.

The second key task of the HTT is to integrate Human Terrain information into the Unit Planning Processes. Once the team has developed a Research Design they formulate a collection plan that will meet the information requirements identified during the Research Design development. This task occurs before specific operations being planned, incorporating the CPE into the unit's mission analysis, proposing non-lethal courses of action, identifying the second and third order effects of possible courses of action, and taking part in war-gaming from the population perspective.

The third key task is providing support to current operations. During an operation being conducted by the unit, an HTT is invaluable. The team takes part in the operation by both monitoring events and on the ground assessments which then provide the Commander and staff

with cultural decision/adjustment points and the outcomes of possible responses. These quick adjustments and mitigating strategies to the operation could be the key to swaying the population away from local threats. Monitoring of events and taking part in the operation by assessments on the ground then feed the cultural aspect of the Commander's Common Operating Picture (COP) by the HTT. Examples of HTT support to current operations are Commander preparations for Key Leader Engagements, building relationships that facilitate meaningful engagements with local power brokers, ethnographic interviews/collection during MEDCAPs/VETCAPs, civil affairs missions, or humanitarian assistance missions. All of these events create an opportunity for the team to gather local cultural information that help shape the unit's operational planning.

The fourth key HTT task is evaluating the human terrain effects of the area of operations. During continuous full-spectrum operations the HTT is continually assessing what effect our operations, as well as threat operations, are having on the local population. Every effect we try to attain against our threats, and every effect they in turn take against us, affects the local populace. The HTT's job is to not only assess what effect is occurring, but also to predict the second and third order effects of possible future operations. In support of the unit, the HTT also assesses the Information Operations measures of effectiveness and performance, recommending adjustments and/or outcomes of the current assessment framework. In turn, the team also evaluates the effects the human terrain is having on our operations and threat operations.

Finally, the HTT supports the unit by training all elements on relevant socio-cultural issues. This is effective on the BCT/DIV staff, but is most effective at battalion-level and below, since they have the primary responsibility for the operational area and have the most contact with the local population. The most basic training involves cultural awareness similar to that done prior to the unit's deployment (i.e. Cultural do's and don'ts), but also includes education on cultural and religious holidays and classes on tribal dynamics and local cultural power structures.

Human Terrain Team Mission Essential Task List	
I. Conduct a Cultural Preparation of the Environment (CPE)	
Design a Human Terrain Research Design.	
Coordinate culture research activities.	
II. Integrate Human Terrain into the Unit Planning Processes	
Develop the Human Terrain Collection Plan.	
Develop Human Terrain information requirements.	
III. Provide Human Terrain Support to Current Operations	
Identify cultural decision / adjustment points that impact the population.	
Develop recommended popular responses or mitigating strategies to gain or maintain support of the local populace.	
Maintain the Human Terrain Component of the Common Operating Picture (COP).	
IV. Evaluate Human Terrain Effects	
Friendly and enemy operations on the human terrain.	
Human terrain on friendly and enemy operations.	
V. Train Support Elements on Relevant Socio-Cultural Issues	

Figure 6 - HTT METL

The end-state of Human Terrain Team support is to provide the unit the reasons why the population is doing what it is doing and thereby providing non-lethal options to the commander and his staff. Military units have incorporated systems to identify and address threats for the entirety of its history, and more recently created systems for the inclusion of subject-matter experts in law enforcement, economics, etc. All of these elements gather information and include their recommendations on courses of actions for the commander. The knowledge gap that HTTs counter is population-focused and designed to assist the unit in preventing friction with members of the local population by identifying local dynamics, grievances and motivations, assessing governmental effectiveness and making recommendations on how to address them. They also voice the second- and third-order effects that are likely to occur based on planned unit operations.

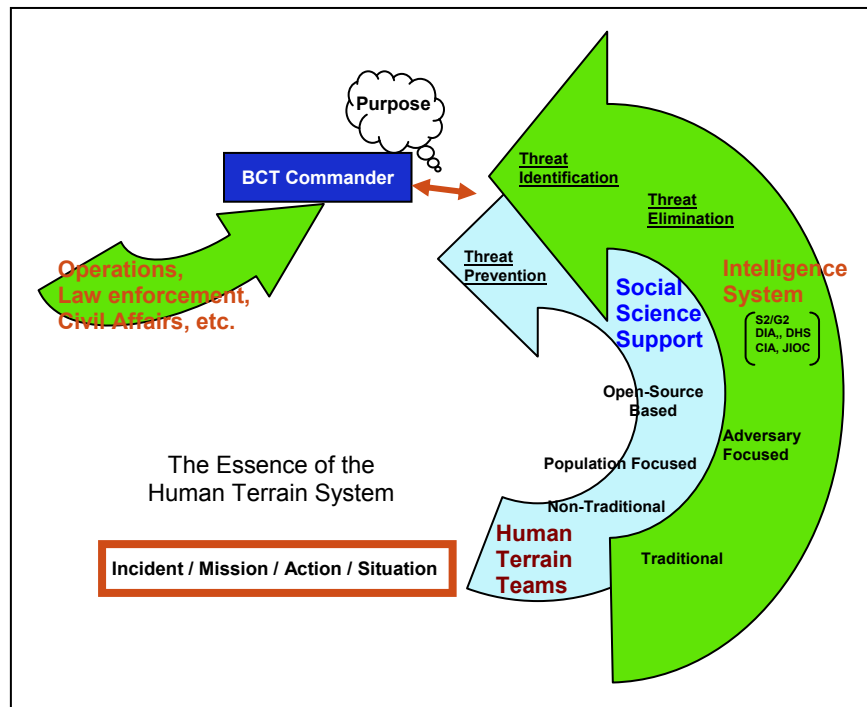

Figure 7 - Social Science Support to Military Operations

All of these key tasks are designed to identify and address the supported units' socio-cultural knowledge gaps and help improve the units' understanding of the local populations in order to enhance their planning and decision-making processes. In order for the Human Terrain Team to accomplish this, the commander and staff must understand how to most effectively employ the team within their area of operations.

Employing an HTT

The Human Terrain Team is fully integrated into the planning processes of the supported unit, with the Team Leader and social scientist as trusted advisors to the Commander and staff. The HTT works with the staff and subordinate units to help ensure all activities of the unit properly take into account the human terrain of the area of operations. HTTs participate in a variety of working groups, cells, and meetings within the staff (i.e. S3 Effects, Battle Update, Information Operations Working Group, etc.). HTT personnel are used across the staff to maximize their ability to improve the human terrain understanding of the area of operations, providing three primary capabilities:

First, *expert human terrain & social science advice* based on a constantly updated, user-friendly ethnographic and socio-cultural database of the area of operations that leverages both the existing body of knowledge from the social sciences and humanities as well as on the ground research conducted by the team,

Second, the ability to *provide focused study* on social science, cultural or ethnographic issues of specific concern to the commander, and

Third, maintain a *tactical overwatch reach-back link* through the Reachback Research Center, which provides direct support to the HTTs and access to its subject-matter expert network and learning institutions throughout the world.

A significant benefit the HTT provides beyond analysis and assessment of local attitudes, perceptions, and behaviors is analysis of how U.S. attitudes and behavior impact on the local populations' willingness to work with Coalition Forces. This allows the supported commander to evaluate the effects of his operations and how to interact with the local population for best effect.³

Task Organization

The Human Terrain Team is attached to the unit and belongs to the Commander, who employs the team as he needs them, just as he does any other asset. The HTT fits within the staff in several ways; as a member of the special staff that reports directly to the commander; from within the Effects/Fusion Cell, reporting to the commander through the Effects Coordinator. In both cases the team leader acts as the human terrain advisor to the commander and staff and the social scientists providing a unique advisory capability to the commander and staff.

³ Karabaich, Bryan, "Human Terrain Team (HTT) Debrief, 31 October-1 November 2007," Center for Army Lessons Learned.

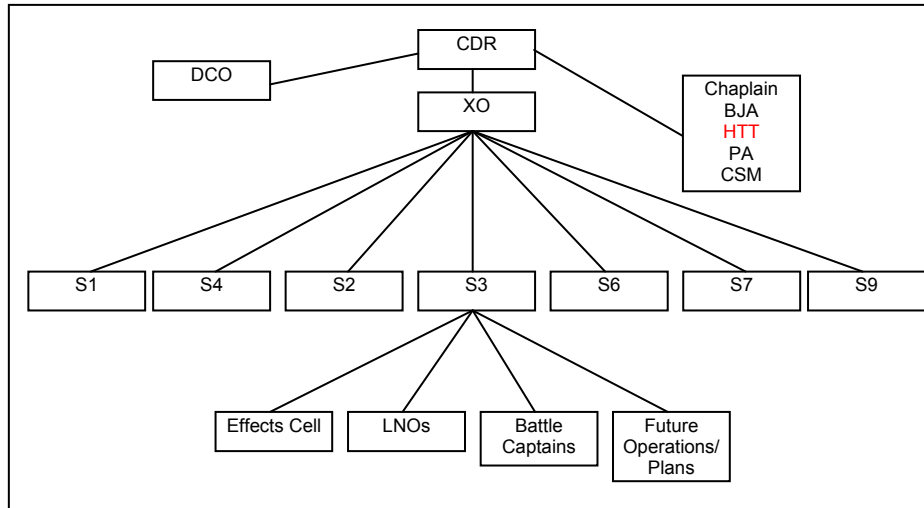

Figure 8 - BCT Staff Organization – Special Staff (Adapted from FM 3-90.6)

Special Staff

As a member of the special staff, the HTT has the most direct access and closest working relationship with the Commander. They receive command and staff direction in the same manner as other special staff elements, from the Commander himself, or the Deputy Commander in his stead. The Commander will determine the extent of the HTT's interaction and relationships with the rest of the staff and subordinate units. Given that HTTs research and analyze human terrain information about the local population, they will typically interact with the S3 Effects Cell (PRT, CA, IO, PSYOP, Law Enforcement Professionals, USAID, etc), the S2 staff section, as well as other staff elements. Human terrain information comes from and is provided to all of these elements.

Effects Cell

When placed with the S3 Effects Cell, the HTT is allowed almost immediate situational awareness and facilitated the most interaction and closest working relationship with the key elements within the staff that address the non-lethal environment (PRT, CA, IO, PSYOP, Law Enforcement Professionals, USAID, etc). They receive command and staff direction in the same manner as other staff elements, from the Commander himself, or the Deputy Commander in his stead. The Commander will determine the extent of the HTT's interaction and relationships with the rest of the staff and subordinate

units. Most of the research and human terrain information about the local population will include significant interplay with the non-lethal effects staff.

Future Operations/Plans Shop

In order to have the most influence on long-term plans and upcoming operations the HTT also supports planning in the Future Operations/Plans Shop. The nature of the HTT's research, which is most effective with a long-range focus, allows the team to identify and address long-term goals and effects desired by the unit; looking ahead three plus months at what the unit has planned and collecting cultural data that would be significant to those plans enhances the planning process.

Human Terrain Team Orientation

Regardless of the position within the staff, the HTT have five possible configurations in which they historically have oriented themselves in order to support the needs of the unit.

Consolidated

Frequently, the HTT is kept together and intact, working on a set of research questions together as a team. Drawing off team members with unique experience and expertise could curtail its ability to support the unit. Keeping situational awareness of the unit's issues and operations is essential to supporting the planning and decision-making processes. This does not prevent support to subordinate units, as long as the mission supports the overall team's research and needs required by the higher headquarters.

Split in Support of the Main Effort

Similar to the consolidated organization, the team is set within the headquarters with a portion of the team consistently focused on whomever or whatever is the main effort for current operations, as well as a portion preparing for future main efforts. This orientation allows for maximum use of the team toward the same goal the unit is focused on for the operation. This orientation would incur significant interaction and time with the subordinate unit.

Sub-Unit Orientation

Another way to organize is the allocation of specific team members to act as liaisons/analysts for each subordinate unit. Each team member can be tasked to focus on human terrain information and cultural knowledge gaps for the subordinate unit, researching to affect their battle-space. The information of each subordinate area of operations can then be analyzed and synthesized amongst the team to give a holistic picture of the higher headquarters' area. This orientation could entail the team member to spend significant time away from the team and among the subordinate unit.

Geographic Orientation

The HTT can also focus specific team members based on specific geographic areas within the unit's area of responsibility. Each team member can be tasked to focus on human terrain information and cultural knowledge gaps for that geographic area, researching to affect the battle-space. The information of each geographic area can then be analyzed and synthesized amongst the team to give a holistic picture of the higher headquarters' area. This orientation could entail the team member to spend significant time away from the team and among the geographic area's responsible command.

LOO Orientation

Another orientation can be focusing analysts based on the unit's Lines of Operation (LOO). Specific analysts can be responsible for human terrain information that affects their particular LOO (i.e. Governance, Economics, Security, etc.) and focus their efforts to address the unit's endstate for that LOO. Due to information crossing the LOOs, the analysts' data should be fed into the overall team for oversight and synthesis. This allows for the team to develop their research based on the unit's campaign plan and influencing its execution through the working groups dedicated to the LOOs.

Battle Rhythm

Deployed teams develop internal battle rhythms that complement the unit's headquarters battle rhythm. The internal battle rhythm helps ensure the team presence in the CP and synchronizes team member

requirements to support and attend meetings, working groups and boards.

<p>0700– Shift-change briefing (chief of staff/CP members).</p> <p>0800–Operation update and assessment briefing (commander, staff, subordinate commanders).</p> <p>0900–G-5 plans update (chief of staff and plans cell).</p> <p>1000–Logistic synchronization conference call.</p> <p>1100–Movement synchronization meeting.</p> <p>1300–Operation synchronization meeting (G-3, chief of operations, and section and cell chiefs).</p> <p>1700–Corps operation update and assessment briefing.</p> <p>1900–Shift-change briefing (chief of staff/CP members).</p> <p>2000–Working groups.</p> <ul style="list-style-type: none"> • Interagency working group (Monday). • Targeting working group (Tuesday, Thursday, Saturday). • Information operations working group (Wednesday). • Civil-military operations working group (Friday). • Assessment working group (Sunday).
--

Figure 7 - Example Simple Battle Rhythm

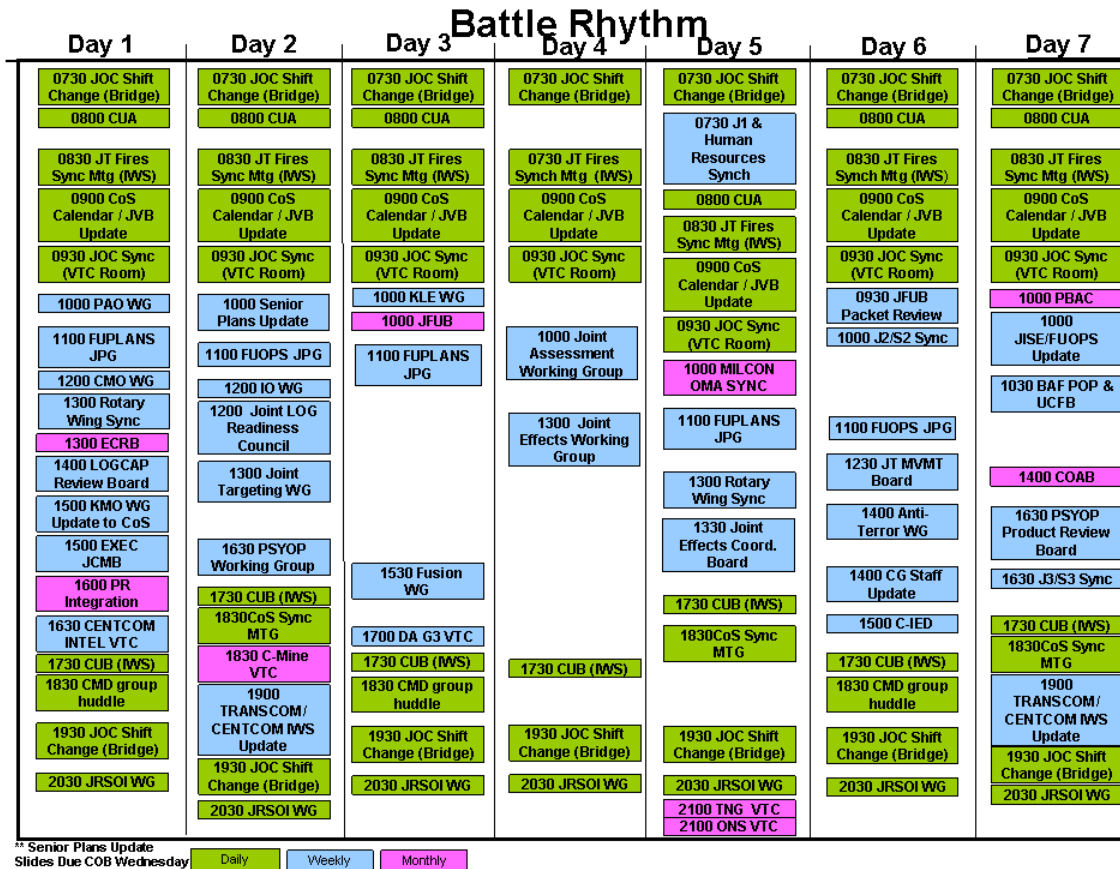

Figure 8 - Example Complex Battle Rhythm

D A Y	EVENTS	Team Leader	Social Scientist	Social Scientist	Research Manager	Human Terrain Analyst
S U N	0700 – O&I Brief	X	X			
	1700 – CUB	X	X			
M	0700 – O&I Brief	X	X			
	0800 – CMO WG			X	X	
	1700 – CUB	X	X			
T U	0700 – O&I Brief	X	X			
	0800 – FP WG			X	X	
	1700 – CUB	X	X			
W	0700 – O&I Brief	X	X			
	1700 – CUB	X	X			
	0800 - IOWG			X	X	
T H R	0700 – O&I Brief	X	X			
	1400 – JARB					*X
	1700 – CUB	X	X			
F	0700 – O&I Brief	X	X			
	0800 – Effects Cell			X	X	
	1600 – Awards	X	X	X	X	X
	1700 – CUB	X	X			
S A T	0700 – O&I Brief	X	X			
	1700 – CUB	X	X			

Figure 9 - Sample Internal Battle Rhythm

Daily Event
Weekly Event
Monthly Event

HTT Capabilities

One of the most important interactions between the HTT and the staff involves the assessment of the population's needs. This historically has come from Civil Affairs units conducting engagement meetings with local government and tribal leaders, and more recently provincial government and tribal engagements conducted by Provincial Reconstruction Teams. Human Terrain Teams bring another aspect of the population: the average persons' perspective. When the HTT incorporates the "grass-roots" perspective with government and tribal perspectives gathered by the CA and PRT Teams, a more robust a clear picture on the needs of the entire population emerges. This in-depth picture can then be infused into planning and military decision making processes to increase positive outcomes.

In addition to drawing upon their own individual experience and expertise, each team leverages the available body of relevant academic field research data in their operational areas. Each team requests and gathers additional data from a variety of sources operating in theater (patrols, civil affairs, SOF, Law Enforcement Program, PSYOP, NGOs, open-source indigenous research, in-country population survey contractors, etc.). HTTs will use the Map-HT Toolkit of developmental hardware and software to capture, consolidate, tag, and ingest human terrain data. HTTs use this human terrain information gathered to assist commanders in understanding the operational relevance of the information as it applies to the unit's planning processes. The expectation is that the resulting courses of actions developed by the staff and selected by the commander will consistently be more culturally harmonized with the local population, which in Counter-Insurgency Operations should lead to greater success. It is the trust of the indigenous population that is at the heart of the struggle between coalition forces and the insurgents.

In order to support below the BCT level, the information generated by the HTT increases the ability of battalions, companies, platoons, and squads to understand the people that they live and must operate with. The HTT capability for detailed research of the local population has application at all tactical echelons, as well as at the operational level of war (theater and division level).

HTTs can also be used by the Commander and S3 to support in-depth cultural training with a clear emphasis on social science that can compliment existing cultural awareness training conducted for leaders, staff, and small units. The human terrain information gathered and analyzed by the teams becomes the content for relevant unit and individual training and education.

Support to Unit Operations Process

HTTs are intended to integrate cultural understanding of the environment throughout the Operations Process by integrating the team into planning, preparation, execution, and assessment in order to ensure that the commander and staff's Common Operating Picture (COP) includes relevant aspects of the cultural environment in developing the plan, carrying it out, and assessing its results. All team members must be prepared to take part in the process. The balance of the members will be engaged in field operations, research, or analysis and product development as part of their internal operations process: planning (developing a research plan), preparing (coordinating with the subordinate units where field operations will be carried out), executing field research, and assessing (through consolidation and analysis of field operations research and other research including interaction with the RRC). All of these actions are conducted to develop relevant products to input to the unit's operations process to ensure the unit has a common understanding of the operating environment that includes cultural understanding. The following discussion incorporates structure that the unit will use to conduct their operations process and the individuals and activities that the HTT will inject into the process.

The HTT will research, interpret, archive, and provide cultural data, information, and knowledge to optimize operational effectiveness by harmonizing courses of action within the cultural context of the environment, and provide the commander with operationally relevant, socio-cultural data, information, knowledge and understanding, and the embedded expertise to integrate that understanding into the commander's planning and decision-making processes.

The team will develop information to compensate for shortfalls in cultural understanding in the force regarding the manner in which operations will be conducted. Lack of cultural understanding has sometimes caused Army units to focus on short-term objectives

without considering the second and third order effects generated by failing to understand the cultural environment and the second and third order effects that could be generated by our operational methods by violating cultural norms. To effectively achieve the mission, the HTT members must understand the operational structure of the unit and through which staff structures to provide information to ensure the commander, staff, and subordinate organizations have visibility of relevant cultural information. They must understand the unit mission and provide insights to effectively accomplish that mission most effectively with full appreciation of the cultural context in which the operation is conducted.

Support to Planning and Decision Making

“Fate is a saddled ass, which goes where I lead it.”
- Pashtun Proverb

HTTs are intended to integrate the human terrain research plan with unit intelligence collection plan/Operations Plans (OPLANs) in order to ensure the unit incorporates operationally relevant human terrain information into unit Courses of Action (COAs). The greatest value of human terrain analysis is incorporated into the planning process to enhance the viability of the unit plan for future operations. The Team Leader normally becomes aware of the desired future operation through the Commander or Deputy Commander (DCO), alerting the Research Manager to engage the A/S3 Plans/S5 as the unit begins planning. From this point, the team participates in planning with the Plans Cell. The HTT Team Leader, based on initial Mission Analysis feedback, develops an HTT Collection Plan in concert with the Social Scientist and Research Manager to conduct an area assessment of the cultural terrain in the anticipated unit Area of Operations (AO). The Team Leader will coordinate the Assessment Plan with the S9 (Civil Military Operations [CMO]) and with the S7 regarding potential civil leader engagement for incorporation in non-lethal targeting. While the HTT is not an intelligence asset, HTT feedback is incorporated into the S2's Intelligence Preparation of the Environment to ensure the commander is apprised of all relevant aspects of the operational environment in which the unit will operate. As such, the Team Leader will discuss knowledge gaps with the staff to incorporate these issues into the HTT Collection Plan. Feedback is provided directly to the S9 and S7, but is made available to the S2, as the information is not the result of an intelligence collection tasking. Based on the HTT Area

Assessment, the team participates in planning to ensure cultural considerations are incorporated in COA Development and Wargaming to ensure the COAs developed and wargamed are Acceptable (in terms of cost and benefit of population support of coalition operations), Suitable (based on consistency of likely popular response with the commander's guidance), and Complete (in terms of achieving not only the tactical end state, but the operational end state expressed in the higher headquarters campaign plan).

The HTT should be present during all stages of the Military Decision-Making Process (MDMP) in order to ensure that situational awareness of the HT is maintained at all times. HTT personnel should have access to research materials and analytical tools in order to quickly identify any risks or challenges associated with new information obtained during operation planning and decision-making.

Receipt of Mission

The HTT must identify all critical elements of the mission as soon as they are released. Cultural analysis of the mission must be available at the start of mission planning.

Mission Analysis

The HTT should present a preliminary cultural terrain brief. The brief should list and describe the indigenous population inhabiting the affected area. This includes tribal affiliations, religious practice, socio-economic status, and current relationship with the US military. The brief should also describe any historical elements of significance relevant to the affected area (i.e. historical landmarks, religious shrines, etc.). Imagery depicting any critical entities (people, places, things, etc.) should be included in this brief. Link Charts presenting any significant persons of influence who may be affected by the mission should be presented. These link charts should illustrate the relationship of the entity to the mission and his/her position within society (including ties to key political figures, threat organizations, etc.).

Course of Action (COA) Development

The HTT should speculate, using historical and/or empirical evidence, on potential 1st, 2nd and 3rd order effects resulting from

hypothesized COAs.

COA Analysis/Comparison

The HTT should continuously produce facts and illustrative examples to convey the significance of different COA. The HTT should prepare visual displays (e.g., imagery, link charts, timelines, etc.) which illustrate the anticipated 1st, 2nd and 3rd order effects of the chosen COA. Illustrative examples in the form of link charts, geographical imagery, etc. communicates a compelling message which can be forwarded up the chain of command to ensure mutual understanding of the cultural environment.

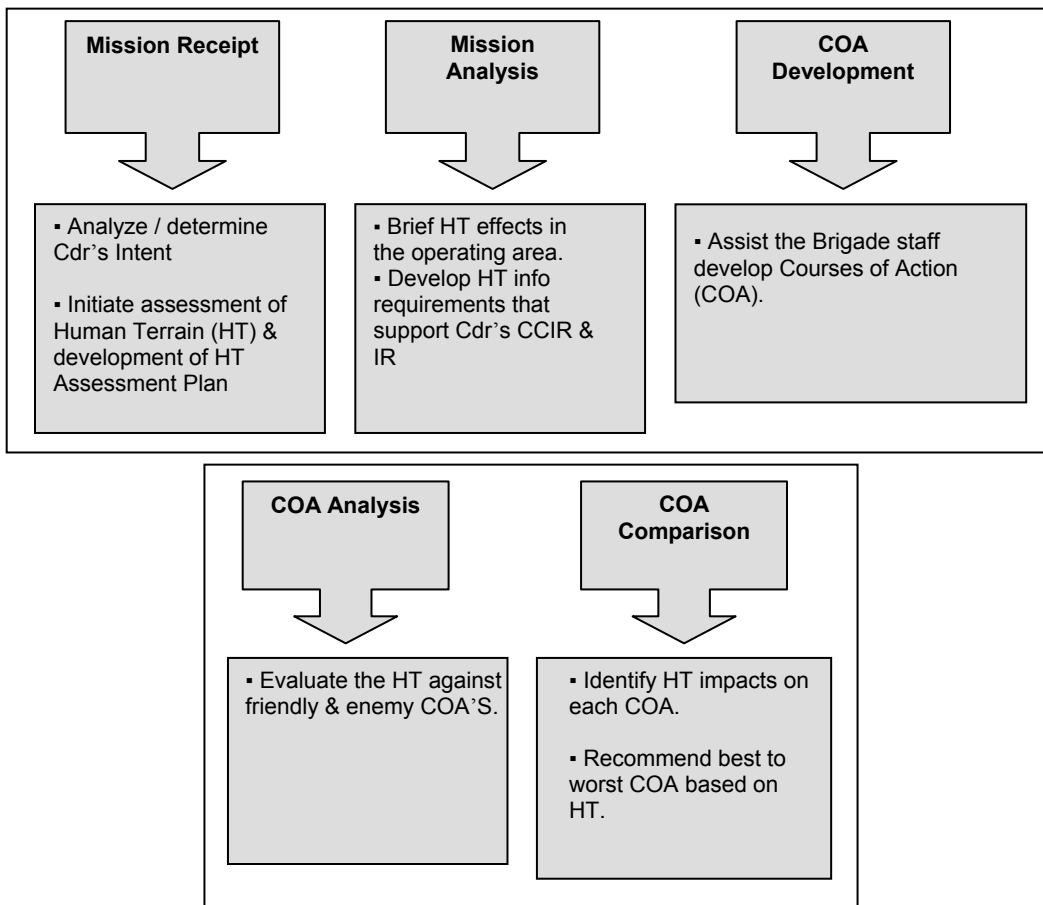

Figure 10 - HTT Support to Planning/MDMP

Working Groups and Meetings

The Team Leader is responsible for coordinating with the commander and staff to integrate the team into unit meetings, working groups and boards where human terrain influence is appropriate. Active participation in appropriate meetings, working groups and boards are the key points in which human terrain information is injected into the planning process and adds relevancy of the team to the unit mission and builds team credibility with the commander and staff.

Periodically or as required, ad hoc groupings form to solve problems and coordinate actions. These groups include representatives from within or outside a command post (CP). Their composition depends on the issue. These groups are called meetings, working groups and boards. Each is a control measure for regulating a specific action, process or function (See JP 5-00.2).

Meetings are informal gatherings used to present and exchange information. CP cell chiefs and staff section representatives hold meetings as needed to synchronize their activities.

A working group is a temporary grouping of predetermined staff representatives who meet to coordinate and provide recommendations for a particular purpose or function. Some working groups may be thought of as ad hoc CP cells. Others are forums used to synchronize contributions of multiple cells to a process. For example, the targeting working group brings together representatives of all staff sections concerned with targeting. It synchronizes the contributions of the entire staff to the work of the fire support cell. It also synchronizes fires with current and future operations. Working groups may be held at a central location, by teleconference, by video teleconference, or by a combination of these. They are formed as needed or when the commander directs.

Typical working groups and the lead cell or staff section at brigade, division and corps headquarters include—

- Operations synchronization (current operations cell).
- Plans (plans cell).
- Targeting (fire support cell).
- Information operations (G-7 staff section).
- Protection (protection cell).

- Civil-military operations (G-9 staff section).
- Information management (C4OPS cell).

The number of and subjects working groups address depends on the situation and echelon. For example, a corps CP may form working groups to address enemy improvised explosive device tactics or refugee return and resettlement. Battalion and brigade headquarters normally have fewer working groups than higher echelons. Working groups there are often less formal. Groups may gather daily, weekly, or monthly, depending on the subject, situation, and echelon.

Working groups form a major part of a CP's battle rhythm. The COS/XO oversees the battle rhythm and working group scheduling. COSs/XOs balance the time required to plan, prepare for, and hold working groups with other staff duties and responsibilities. They also critically examine attendance requirements. Some staff sections and CP cells may not have enough personnel to attend all working groups. COSs and cell leaders constantly look for ways to combine working groups and eliminate unproductive ones.

It is desirable that the same team member routinely attend the same working group. The team member designated to attend a working group makes routine checks of other team members for any input and shares the outcome of the working group with the entire team as soon as possible. Generally, meeting and working group agendas address the following:

- Purpose.
- Frequency.
- Composition (chair and attendees).
- Inputs and expected outputs.
- Agenda (HTT Briefing and/or Discussion)

Support to Pre-Planning Information Gathering (Assessments)

Units will normally want to understand the cultural landscape of the environment in which they operate prior to initiation of operational planning. In this endeavor they need to consider and understand the nature and intricacies of the governmental, economic, security, educational and health care institutions within their operational environments in order to properly facilitate the advancement of these

institutions, to maximize the preservation of their forces and resources and to develop plans centered on America's current applicable doctrine (counterinsurgency, nation building, advising, occupation, peace keeping, etc.) The HTT is responsible for providing assessments of attributes of the human terrain in response to these requests, providing the supported unit with a more comprehensive understanding of their respective area of operations. Assessments will typically fall into one of the following categories:

- **Current Institutions** – Assessing the structure, function and cultural and social influence of the area's extant institutions (governmental (formal and informal), economic, security, legal, justice, essential services, social programs, religious, health care, postal, media, NGOs/charities, educational, etc.)
- **Historical Institutions** – Assessing how the current institutions, and those no longer in operations, operated under previous administrations, and how the populace felt about those institutions and their operation. The HTT may also be required to assess the history of social organizations, naming conventions and landmarks.
- **Spheres of Influence** – Assessing the most influential individuals in their respective societies and communities, their social networks, the source of their influence, and how they could be engaged to further the unit's purposes.
- **External factors influencing the operating environment** – Assessing institutions that are not necessarily considered the nation's institutions, but that exert significant influence on the nation's policies and decisions. Influence from neighboring countries and foreign religious bodies would fall into this category.
- **Demographics** – Assessing the composition of the population itself, to include such factors as literacy, employment, education, race, age, gender, socioeconomic status, etc.

- **Social organizations** – Assessing the composition, hierarchy, and influence of different strata of the social structure (tribal alliances, individual tribes, clans, families, individuals, etc.)
- **Area** – Providing comprehensive assessments on designated areas. These assessments could be regional or provincial, or simply a neighborhood block. Units may be struggling with a particular area and want the HTT to compile as much information as possible to determine the most informed course of action.
- **Infrastructure** – Assessing the area’s rail lines, oil pipelines, sewage and water system, electrical grid and capacity, communications infrastructure, agricultural lands, etc. allows the unit a look at what is available for restoration, the services the populace is accustomed to, what needs to be secured, what can be manipulated to achieve the unit’s purposes, etc.
- **Religious factors** – Assessing the area’s primary religious influences, their identity, structure, organization, beliefs, doctrine, holidays, and the views of their extremists.
- **Identities** – Assessing how a population identifies itself socially, culturally, religiously, within a family structure, globally, individually.
- **Cultural nuances** – Assessing the unique features of a given society. These factors are important in understanding non-Western societies and for the purpose of interacting appropriately with foreign cultures.
- **Social norms, tolerances, and processes** – Assessing a society’s personality, including such disparate elements as how the society resolves disputes; attitudes toward bureaucracy, violence, capitalism, corruption; business practices; negotiations, etc.

- **Popular attitudes** – Assessing a population’s collective mentality; attitudes toward modernity, religion, foreign presence, etc.

Support to Unit Engagements

The HTT can be invaluable to the commander in his preparation and conduct of key leader engagements and can be an extremely effective mechanism to engage with the population and leverage the effects of operations. The team systematically conducts network analysis of power structures and spheres of influence within the area of operations to identify who the commanders should be interacting with and in what capacity. They can then identify and foster the building of relationships with those power brokers to facilitate positive engagements and cultural understanding between the parties. Post-engagement the team provides the commander a back-brief and/or report describing an independent analysis of the human terrain information gathered at the engagement and cultural cues (spoken and unspoken) identified throughout the event and their significance.

Support to Reconciliation

The HTT can be a key resource in promoting the reconciliation process by building relationships with local power brokers, particularly actors previously viewed as irreconcilable. By building relationships through the exploration of existing relationships (by following the local tribal and religious cultural structures) the team can bring the required local leaders to the negotiation table.

The information through which the team identifies the power brokers is based on local social, economic and political data within the area of operations. Social data related to reconciliation exists on three levels. The neighborhood in which the reconcilers operate possesses certain demographic characteristics. This includes population density, family size, education levels, tribal affiliations, and sectarian identity. Once this census data is collected, potential reconcilers can then be situated by their sectarian, tribal, and family connections. These connections can be mapped, the result of which is a picture of the social network.

The social level also includes institutions. These may be mosques and churches, recreation centers, criminal gangs, women’s groups,

and non-profit organizations. Individual ties to each of these institutions can be identified. In addition to the demographic level and the institutional level, there is the level of peoples' perceptions and attitudes. People behave in certain ways and adopt certain habits as a result of their upbringing and their experiences. Knowledge of these habits and perceptions can be brought to bear when trying to understand what is promoting and what is hindering the reconciliation process. If residents of the neighborhood do not come out publicly and support reconciliation, it may be due to the prior patterns of survival adopted during previous regimes, rather than due to any opposition to reconciliation. Understanding this behavior pattern can then assist in tailoring the reconciliation process in such a way such that it is viewed as neutral and non-threatening. Rather than being perceived as favoring one party or another, reconciliation can be conducted by impartial mediators. The reconciliation message might work better if it is couched in terms of benefiting everyone, rather than just the reconcilers.

Other connections occur at the economic level. One can begin at the demographic level by mapping the income levels in the neighborhood. Layered on top of that is a representation of the economic institutions in the neighborhood. These include businesses such as restaurants, movie theaters, coffee houses, banks, etc. Each neighborhood experiences patterns of money flow, both into the neighborhood and out of the neighborhood. As a resident, the person in our example is plugged into this money flow. A question that can be asked is: What is the source of wealth generated by this individual that is contributing to the neighborhood's economic resources, and what is the destination of wealth this individual extracts from the neighborhood? When reconciliation is perceived as supporting neighborhood development then more people are likely to support it. This perceptual is also important when it comes to what people say about reconciliation. Is it a new trick by high level government officials to make money, or is it a chance for businesses to thrive in an environment of stability?

Another process that occurs in any neighborhood is the creation and destruction of social, economic and political obligations. People do favors for each other. They help their friend's kids succeed in school. They give out loans to each other. They let their relatives use their cars. They vote for the candidate favored by their tribe. All of these exchanges of favors and resources are a part of the cultural landscape

of the neighborhood. By mapping this landscape, decision-makers can make more informed decisions about how to encourage participation by those who might be helpful to reconciliation.

Finally, power plays an important role in every neighborhood. There are some groups that have more power and some groups that have less. Reconciliation may empower those who are weaker. If the individual in this example belongs to a weaker tribe, reconciliation may be a path to empowerment. On the other hand, he may be associated with a powerful political party. Reconciliation may be a threat to their power if they oppose it, so the party's support for reconciliation may give this individual an incentive to support it as well.

Additional factors can be weighed in as well. Many tribes subscribe to a process of mediation (i.e. *sulh*, *shura*, etc.). A mediator can bring together two tribes that have been fighting each other, in circumstances where the tribes would not engage in negotiations on their own.⁴

Support to Information Operations

The HTT can provide significant cultural input and recommendations to the Information Operations and Psychological Operations. This can come in many forms, but has historically been most beneficial by ensuring the cultural context and making recommendations on IO themes and PSYOP products, identifying population sentiment toward the unit and their operations, and consequence management of the messages. The team also reviews the IO Measures of Effectiveness and Measures of Performance for applicability for the assessment of the human terrain. Identification of key persons of influence for social engagement also falls within the realm of IO.

⁴ Altalib, Dr. Omar, "Helping Reconciliation Succeed – The Role of the Human Terrain Team."

Relief in Place/Transfer of Authority

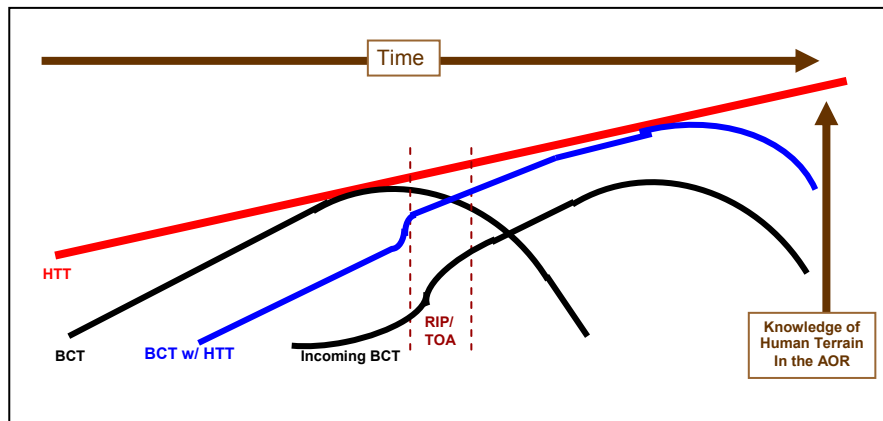

Figure 11 - Relief in Place/Transfer of Authority Learning Curve

The Human Terrain Teams, who are geographically located and whose tours of duty are carefully managed to overlap those of the supported units, will also be critical to the smooth and complete transfer of local area knowledge, human terrain understanding, and maintaining momentum during unit Relief in Place/Transfer of Authority (RIP/TOA). This overlap will allow the incoming commander and staff to have an immediate source of socio-cultural knowledge for key leader engagements as well as in their planning processes from the moment they hit the ground.

“We were way off the mark on cultural awareness. We did not study the different tribal affiliations or extremist interoperations and their effect on the areas we operated in. We expended too much effort trying to understand what was offensive or polite interaction with the populace.” – Command Sergeant Major, Battalion, CALL’s First 100 Days Commander and Staff Handbook

All units conduct cultural awareness training prior to deployment, where leaders and soldiers learn the do’s and don’ts of the culture in which they will interact. However, in order to truly understand the local population and properly nest plans according to them, the commander and staff need a resource to tap that has more than awareness, but a deep understanding. Providing this capability, the HTT improves the cultural understanding start-point for the commander and staff of the incoming unit.

During the RIP/TOA, the HTT should be tied into every aspect of the joint-planning and cultural engagements done between the incoming and outgoing units, particularly introductions with local community, government and tribal leaders to the incoming military leadership.

Sustainment and the HTT

The HTTs do not have organic transport or sustainment equipment for operations away from the unit's HQ and team members carry self-defense weapons only, therefore require all logistical support from the unit, including billeting, rations, security, and working space. This also includes transportation for research amongst the local populations.

Transportation

Inclusion into pre-planned patrols and/or missions designed to utilize the HTT on the ground, as determined by the Commander, are required for the teams' movements around the area of operation. Field research work is closely coordinated with PRT, CA, PSYOP and local maneuver organizations (battalion and lower) in the relevant area of HTT research. Essentially, any element that is able and willing to transport and utilize the team is leveraged for movement.

Equipment

Team members do have organic computing equipment that can operate at and away from the HQ, including the Map-HT (Mapping the Human Terrain) system. The Map-HT system is a computer suite of hardware and software that allows the team to conduct cultural information management as well as analyze human terrain data collected in the field. The system is used by both deployed teams and the CONUS Reachback Research Center, facilitating data-sharing and cooperation. The core software components (Analyst Notebook, ArcGIS, Anthropac, UCINet and NetDraw) allow the team to conduct network analysis, Modeling and Pattern analysis and geo-spatial analysis that place those people and events in place and time. This then adds to the human terrain information that the team incorporates into the unit planning processes.

Ultimately, a Human Terrain Team enables unit Commanders and their staffs the ability to operate with specific, local population knowledge, giving them the ability to make culturally relevant operational decisions. This will enable them to increase support for the elected government and reduce support for insurgents and their operations. Additionally, this prevents the creation of new insurgents and reduces public support for the insurgent organizations, which over time will reduce the motivation that underpins insurgencies and radicalism.

Chapter 4

Methodology

Let us start with Bernard, who tells us that “research methods in anthropology (methods for designing research, methods for sampling, methods for collecting data and methods for analyzing data) must all be done twice; once for the qualitative data and once for the quantitative data.” The best way to achieve this is to conduct research and gather data using a mixed methodology framework.

Bernard also calls “research is a craft” and, like all other crafts “takes practice, practice, and more practice.” Some of this practice should come from your training, but the more you conduct in theater, the more proficient the team will become. Remember, you should “never expect to do perfect research. Just expect that each time you do a research project, you will bring more and more experience to the effort and that your abilities to gather and analyze data and write up the results will get better and better.”⁵ There are several chapters in his book: Research Methods in Anthropology: Qualitative and Quantitative Approaches 4th Ed. team members should be familiar with: Chapters 2, and 9-21. Other books that you should also read are Spradley’s The Ethnographic Interview and Spradley’s Systematic Data Collection.

Cultural Preparation of the Environment (CPE)

The purpose of the CPE is to gain an understanding of the cultural environment that will provide advice on interacting with the civilian population, constrain or expand the friendly courses action; to anticipate, not predict, adversarial (combatant and noncombatant) action to military operations, and potential hot spots through ongoing process of identifying the local populations.

The four steps to the CPE follow the same doctrinal principles and four-step methodology of the traditional IPB as described in FM 2-01.3, Intelligence Preparation of the Battlefield. To focus the

⁵ Bernard, Russell H, Research Methods in Anthropology: Qualitative and Quantitative Approaches. 4th ed. AltaMira Press, 2006. pp.1-2.

analysis on the cultural environment, it may be useful to describe CPE steps as follows:

IPB Step	Cultural Information Focus
1. Define the Operational Environment	Identify Physical and Human Terrain
2. Describe the Environmental Effects	Describe Civil Considerations (ASCOPE)
3. Evaluate the Threat	Identify Social and Political Patterns
4. Determine Threat COA	Identify Key Friction Points or Misconceptions

The large portion of the work on CPE will be done in reference to ASCOPE, as identifying the civil considerations in the operating area can create a baseline for recognizing normalcy and change from it. Interventions into this “normal” can then be gauged and adjusted based on the populations’ perceptions. The format of ASCOPE used by an HTT stems from FM 3-24 and includes:

ASCOPE

AREA (Key Civilian Areas are localities or aspects of the terrain within an AO that have significance to the local populace; represented by maps with subsequent assessments of how each affects the population and is part of a socially integrated society):

1. Areas defined by political boundaries such as Districts, Municipalities, Provinces
 - a. Acquire maps from Map Terrain Team with a .pdf file for each layer
 - b. District Boundaries
 - c. Muhallah boundaries per District
 - d. Muhallah per Hayy
 - e. Acquire high resolution image of each Muhallah from TIGR
2. Areas of high economic value
 - a. Market/shopping complexes
 - b. High property value residential zones
 - c. Industrial and technical parks
 - d. Natural resource zones (water, mineral, forest, oases, riverside corridors)
 - e. Trees, parks, open spaces
 - f. Cropland, fisheries

3. Centers of government and politics
 - a. District Council Hall
 - b. Neighborhood Council Hall
 - c. Government Ministry Offices
4. Culturally important areas
 - a. Archeological and Historical resources
 - b. Sacred sites and landscapes
5. Social, ethnic, tribal, political, religious, criminal, or other important enclaves/neighborhoods
6. Trade routes and smuggling routes
7. Possible sites for temporary settlement of dislocated civilians or other civil functions

STRUCTURE:

1. Headquarters for Security Forces
2. Law Enforcement
 - a. Police Stations
 - b. Courthouses
 - c. Jails
 - d. Checkpoints
3. Communication/Media Infrastructure
 - a. Radio towers
 - b. T.V. Stations
 - c. Cell Towers
 - d. Newspaper Offices
 - e. Printing Presses
4. Roads & Bridges
 - a. Bridges
 - b. Roads
5. Ports of entry
6. Dams
7. Electrical Power stations and Sub Stations
8. Refineries/Other fuel sources
9. Potable Water
10. Sewage System
11. Clinics & Hospitals
12. Schools/Universities
13. Religious Places of Worship
14. Banks/Financial Institutions
15. Markets

CAPABILITIES (save, sustain, and enhance life):

1. Public Administration
 - a. Bureaucracy
 - b. Courts
 - c. Other parts of Government
2. Public Safety
 - a. Military
 - b. Border
 - c. Police
 - d. Intelligence Orgs
3. Emergency Services:
 - a. Fire Department
 - b. Ambulance Services
4. Public Health
 - a. Clinics
 - b. Hospitals
 - c. Veterinary
5. Food
6. Water
7. Sanitation
 - a. Sewage
 - b. Trash

ORGANIZATIONS (Influence on population):

1. Religious
2. Political Parties
3. Patriotic/Service Organizations
4. Labor Unions
5. Criminal
6. Community Organizations
7. Multinational Corporations
8. International Government Organizations
9. Non-Governmental Organizations

PEOPLE (non-Military, Local National, in/out of OE effecting Operations):

1. Society
2. Social Structures
 - a. Groups
 - b. Networks
 - c. Institutions
 - d. Organizations

- e. Roles/Status
- f. Social Norms
- g. Culture
- h. Identity
- i. Cultural Forms
 - 1) Narrative
 - 2) Symbols
 - 3) Rituals
- j. Beliefs and Belief Systems
 - 1) Core beliefs
 - 2) Intermediate beliefs
 - 3) Peripheral beliefs
- k. Values
- l. Attitudes
 - 1) Social groups
 - 2) Ideologies
 - 3) Government
 - 4) U.S. Forces
- m. Perceptions
 - 1) Power
 - 1. What type of power does the group have?
 - 2. What do they use their power for?
 - 3. How is their power acquired and maintained?
 - 4. Which leaders have power within particular groups?
 - 5. What type of power do they have?
 - 6. How is their power acquired and maintained?
 - n. Interests
- 3. Physical security
 - a. Is the civilian population safe from harm?
 - b. Is there a functioning police and judiciary system?
 - c. Are the police fair and non-discriminatory?
 - d. If the police are not providing civilians with physical security, who is?
- 4. Economic resources
- 5. Political participation
 - a. Do all members of the civilian population have a guarantee of political participation?
 - b. Is there ethnic, religious, or other discrimination?

- c. Is the government violating human rights?
 - d. Is there an occupying force in the country?
 - e. Do all civilians have access to basic government services, such as health care, sewage, water, electricity, and so forth?
 - f. Are there legal, social, or other policies that contribute to the insurgency?
6. Grievances
- a. What are the insurgents' grievances?
 - b. What are the grievances of the population?
 - c. Would a reasonable person consider them to be valid? Validity of grievance is not effectively assessed by objective condition.
 - d. Are the articulated grievances of the population and those of the insurgency the same?
 - e. What does the government believe to be the grievances of the population? Does it consider those grievances to be valid?
 - f. Are the articulated grievances of the population the same as those perceived by the government?
 - g. Has the government made genuine efforts to address these grievances?
 - h. Are these grievances practically addressable or are they beyond the immediate capacity of the government (for example, major social and economic dislocations caused by globalization)?
 - i. Can U.S. forces address these interests or grievances to elicit support from the civilian population?
7. Additional Civil Considerations
- a. Languages and dialects spoken by the populace.
 - b. Nonverbal communication, like hand signals and gestures.
 - c. Education levels, including literacy rates, and availability of education.
 - d. Means of communication and its importance to the populace.
 - e. Interpersonal via face-to-face conversation, e-mail, or telephone.
 - f. Mass media, such as print publications, radio, television, or the Internet.
 - g. National history and political history.
 - h. Events leading to the insurgency.

- i. Events contributing to the development of the insurgency.
- j. The availability of weapons to the general population.

EVENTS

1. National and religious holidays
2. Agricultural crop/livestock and market cycles
3. Elections
4. Civil disturbances
5. Celebrations

The methodology used to implement and gather information for ASCOPE begins with assessing and analyzing available data. This includes Psychological Operations, Civil-Military Operations, Human Intelligence, Provincial Reconstruction Team, and Unit Patrol Reports, data placed on TIGR, use of Open-Source Intelligence, and interviews of soldiers, officers and interpreters that consistently patrol. From there the HTT conducts field research by joining patrols and other events within the populations. Once data has been gathered it is analyzed and synthesized, then added into TIGR and distributed to the appropriate actors.

Development of a Research Plan⁶

Before the team conducts research they must create a proposal for funding that contains a research design justifying the purpose, data collection methods, resource requirements, personnel, cost, timeliness and significance of the project. An accompanying document is written outlining how the research will comply with the protection of human research subjects according to 45 CFR 46 to ensure the research falls within accepted ethical guidelines.

Therefore, the activities of each Human Terrain Team will be guided by an Ethnographic Research Design. Like all well-planned research, these designs will be based on research problems phrased in terms of a thesis. The problems themselves will refer to a particular social theory. These problems are tested through hypotheses which enable the researcher to test their explanatory force. The data that result are

⁶ Drawn from recommendations from Dr. Marcus B. Griffin, HTT IZ2.

used to validate or refute hypotheses, demonstrate the validity of the thesis statement, and by doing so affirm the overarching social theory's utility as a way of understanding the social world.

As part of the research, we will eventually use the Organization of Cultural Materials schema in order to contribute our research results to an existing database of cultural practices and social systems known as the Human Relations Area Files (HRAF) housed at Yale University. This practice allows us to provide significant, abundant, and contemporary socio-cultural information that others around the world may use in their own research. This practice will also allow us to tie into the HRAF database and compare the existence of one social practice, symbolic system, or historical process in our area of operations with others elsewhere in the world. Such cross-cultural analysis enables us to get closer to explaining causation and make weak assertions of what will likely happen in the population in the near future.

This approach allows HTS to be proactive and transparent. We rightfully claim to be qualitatively different from what entities like Civilian Affairs, Intelligence, PSYOP, and Information Operations do and we are subsequently impervious to claims that we engage in clandestine research. The results of our research provide non-target data that suggests Courses of Action to the commander and his staff. Our research is performed in the same manner in which academic social scientists conduct their research and is similarly rooted in theory and complete with ethical review boards. A significant benefit is that we enter the field with a plan for our daily activities and are not waiting around for someone in the unit to ask us to do something that may be of an intelligence nature that compromises our ethical integrity and claim to being different from what already exists.

HTS research designs will have the following basic structure. Actual projects should be determined through group discussion and prioritization.

Title:

Overview:

Thesis:

Research Design:

Hypotheses:

Data Collection:

Timetable:

Milestones

Resource Requirements:

Equipment

Personnel

Expenses

Travel

Significance

Contribution to Baseline Knowledge

Contribution to BCT Operations

References:

HTT Mission Focus⁷

There are three primary categories for each HTT mission: Pre-mission objectives, Mission objectives, Post-mission objectives. Each HTT is unique and requires flexibility; however the previously mentioned categories are constant, though the sub-categories will certainly be dynamic and reflect the objectives, goals, and products for each mission.

Pre-mission Objectives

Pre-mission objectives are pre-mission coordination activities in order to understand the needs of the customer—whichever unit/element with which the HTT embeds, educate ourselves on the area in which we will be operating, and then develop methods and tools to gather, organize, and analyze the information we gather in order to present our findings to the customer.

The first step of this process is combing through our collection of data in order find out what we already have on the area. It is very important to do a pre-mission data pull, before requesting information products from the Reachback Research Cell (RRC) The RRC can be of assistance if they are given enough time to develop a product.

⁷ Created by Tom Garcia, HTT AF1R.

This second step is the key to stepping off with the correct foot, focusing HTT research, creating or tailoring interview techniques and tools in order to gather the desired information and data from those whom will be interviewed. This step also requires a lot of coordination in order to set up the meeting with the host unit/element; it is most beneficial to accomplish this as far in advance of the mission start date as possible. That sounds like common sense, but it can sometimes be pushed aside, inadvertently.

The intent of this step is to align the proverbial ducks in a row, thus understanding the customer, their needs, and on what the HTT should focus. The initial question should be in the effort of understanding what the customer wants to know, and what they are trying to: know, understand, and/or achieve. Typically, the question is simply asked directly: “What is your goal? What do you want to know or understand? What are the desired effects you are trying to achieve?” Please be mindful that a very important part of what we, HTT, do is to identify and foresee the tertiary effects of the actions that have been or may be taken. It is being able to identify these items which allow us to present our information in such a manner as to support future plans, or discourage those actions—shaping the Battle Space. Our role in that effort is rooted in our ability to bring a different perspective to the table; we understand what our customer wants; we develop methods and tools to gather the information; we organize, analyze, and report our findings relative to the area of operations, and overarching objectives of the battalion and the brigade.

The third step this process is come together as a group to identify themes from the customer based on the pre-mission known. In this “white-boarding” session we attempt to identify the salient topics of interest. However, it must be kept in mind that this is what the customer *thinks* he wants. The customer may always be right in business, but the customer does not always know exactly what he wants. Therefore, our goal in the white-boarding sessions is not only to identify the themes, but also to attempt to understand what they customer needs based on what he thinks he wants. Are you tracking me? For instance, the Maneuver commander wants to know about the tribal dynamics, when economics is a much more larger and important item to consider because it has more impact on the Battle Space.

1. Pre-Operation Objectives

a) Interview and coordinate with unit staff and elements

- i. Define goals (for HTT and the unit)
- ii. Define desired effects
- iii. Determine potential second and third order effects
- iv. Define desired information
- v. Identify domains
- vi. Determine metrics for success

b) Area of Interest Assessment

- i. RFR to RRC
- ii. Basic Research
- iii. RFI to local cells

2. Operation Objectives

c) Tactical Team Coordination

- i. Define goals
- ii. Define desired effects
- iii. Define desired information
- iv. Identify domains
- v. Determine metrics for success

d) Potential Interests

- i. ID key informant
- ii. Seek out females for interviews
- iii. ID centers of gravity
- iv. Authority figure
- v. Village History
- vi. Tribal Information (structure, alliances, feuds, etc)
- vii. Education
- viii. Social Network Mapping
- ix. Healthcare
- x. Roads
- xi. Economy
- xii. Crops and Animals
- xiii. Corruption
- xiv. Needs

c) HTT Interests

- i. Perception of ... (CF, Local Army, Local Police)
- ii. Better cooperation
- iii. Visions for the future
- iv. Expectations for self, family, children, village
- v. Perception of government (National, Provincial, District, Village)
- vi. Primary source of information
- vii. Depth of Tribal Identity
- viii. Definition of age groups. (child, adolescent, adult, elder)

3. Post-Operation Objectives

- e) Village re-assessment
- f) Area re-assessment
- g) Compare with pre-mission and mission assessments
- h) Assess impact of operations on populace
- i) Attempt to identify unexpected second and third order effects
- j) Analyze/assess expected second and third order of effects
- k) ID sustains
- l) ID improves
- m) Identify and capture HTT lessons learned and TTPs

Interview Form

The following items are essential elements of information in order to create qualitative data from the quantitative data HTT collects.

Date:

Time:

Location:

Source: Direct Translated

**Method of Interview: Unstructured Semi-Structured
Structured**

Interview Frequency: Initial Follow-up Repeat

Demographics:

- 1) **Respondent #:**
- 2) **Age Group (>20, 21-30, 31-40, 41-50, <50):**
- 3) **Gender:**
- 4) **Super Tribe:**
- 5) **Sub-Tribe:**
- 6) **Village Name of Residence:**
- 7) **District**
- 8) **Province**

Unit Themes

Work to discover information about themes/goals during the interview. These will be the centers of gravity for the operation, and the basis from which Command will generate the questions you are attempting to answer.

Military/Village/Local/HTT

Keep the listed items in mind when interviewing. These items are not all inclusive. Often times, your subject will present new items or information that will lead you to new discoveries. Set your sails to

catch the wind, and see where you go. However, keep in mind that you cannot control the wind, but you can control your sails.

The information regarding the themes and interests will 1) Identify domains, 2) Animation points, 3) Answer levied questions, 4) create more questions, 5) provide cultural insight, and 6) allow HTT to extract information that can be presented in a quantitative format.

HTT Perspective and Analysis

During and after interviewing, attempt to develop an HTT perspective and how this information you are gathering is **OPERATIONALLY RELEVANT**. The operational relevance of the information will be what gets sent to Command, and will be what they want to know. The HTT analysis of the information will provide a more detailed, cultural perspective

A sample Research Plan can be found in Appendix C.

Methods

The methods chosen to address the teams' research plan are dictated by two factors; where the research request is coming from, and the timeline available to acquire the necessary information.

Research questions can come from two principle sources. Until units become familiar with how an HTT works and where they fit into the planning processes, the teams' primary avenue of research questions are developed by the team itself, addressing what they view as the socio-cultural knowledge gaps of the unit. Based on the commander's priority information requirements and the focus of operations, the teams can ascertain areas in which they can best affect the unit. The second source of research requests come from the unit itself, generally tasked by the commander based on a need he sees the team can fill.

The self-directed research is beneficial because it allows the HTT to affect planning and operations where they know their capabilities can best be used. However, fusing that information into the unit's processes is more difficult, and needs to be sold to the commander and staff after planning has already begun.

In contrast, directed research places constraints upon the team, possibly not using all of their capabilities or not to their full potential. It is beneficial, however, in that by tasking them within the current planning and information-gathering efforts the team will get their thoughts and recommendations into the planning processes earlier, making a quicker impact.

The time available for research also falls into two categories; long-term and short-term. Long-term research is the more favored of the social sciences, and therefore the HTT. The longer a team can observe and research issues and populations, the more defined a picture becomes and greater the understanding can affect planning. Short-term projects can be turned into long-term, but are primarily short due to operational constraints. In full-spectrum operations the unit's planning is constrained and therefore input must be timely and relevant. To make a significant impact, the HTT must be able quickly and accurately address short-term research questions while populating long-term research with information that will more significantly affect unit planning in the long-term.

Ethnographic research

There are three ways to conduct ethnographic research for the unit. 1) Conduct individual fieldwork by accompanying units that conduct operations within the local populations, 2) train local national informants to ask survey questions in lieu of or conjunction with the HTT on the ground and 3) train Company Commanders, Platoon Leaders and their soldiers to see the world from a social science perspective so they can conduct ongoing collection of the populations in their areas. Collecting and synthesizing all the information from these various sources assists the team to create a more in-depth picture of the local populations for the commander and his staff.

Interviewing⁸

Interviewing skills are extremely important for a member of a Human Terrain Team. Interviewing can also be one of the most challenging tasks you will face. Most people do not have much experience conducting interviews; even seasoned interviewers are always

⁸ Garcia, Tom, "Interviewing 101 for the Human Terrain Team," March 2008.

learning new techniques, enhancing their skills, and developing their personal interviewing style. We gather the majority of our information from interviews, in the field or on a base, and it is for this reason that one must work very hard to develop a good interviewing style—and overcome any fears about interviewing you may have. You can learn the basics of interviewing by reading about them, but actually applying the techniques is very different. The only way to learn how to conduct an interview or improve your skills is by practice. Every interview session will be different, even if you are following a structured interview survey form. The dynamics in interviewing come from you and your informant (or respondent, key person, interviewee, etc.)

Gathering information from local knowledgeable sources (LKS) is the primary means by which you will employ, develop, and enhance your interviewing skills. The information you gather, regardless of the method or type, can be used for qualitative or quantitative products. Qualitative and quantitative methods and products are very different animals that serve different purposes and are used for different audiences. However, using both during an interview can—and should—appear to be seamless.

A simple explanation of qualitative and quantitative can be reduced to this: qualitative research is descriptive in nature, whereas quantitative research focuses on numbers or quantity. Qualitative research seeks to describe relationships, the observed environment, processes, etc. Quantitative research seeks to represent the same information by transforming the information into statistical data and using that data to provide visual-statistical representation in the form of graphs scatter plots, network analysis, etc.

All interviews about a single subject have comparable units of analysis (CUA); it is these little gems that can result in the most beautiful visual depictions of your efforts that can be incorporated into a PowerPoint presentation (the language of the military).

A Human Terrain Team should use a mixed methodology using both qualitative and quantitative techniques. Both of these techniques are necessary to fully and effectively communicate our message to our audience. The challenge here is simply learning how to incorporate both techniques into a research design and your interviewing techniques.

Field notes are another important skill-set that a member of the Human Terrain Team must develop. Though there is not a single proper or correct method or format for taking field notes, there are several key items that will make post-analysis and writing much easier. It is also important that consistency is implemented. The main point to keeping in mind about taking field notes is this: Field notes are all that you will return with from a mission; you will develop all post-mission products based on field notes. Field notes are everything.

Planning and Organization

Success of any project depends on proper planning and organization. The same is true for any HTT research project or mission. Identifying what you want to research—discover—or what your customer, the unit with which you will embed, wants to learn is where planning begins. For example, a PRT commander says that he does not understand the tribal dynamics of the area, and that he would also like to know the “pulse of the population.” How are you going to answer his questions during the mission as well as post-mission? What areas will you focus on in order to answer the tribal dynamics? What questions will you ask of the PRT commander? Do you know what the “pulse of the population” means? Is your definition the same as the PRT commander’s? Does your definition really matter?

Defining and understanding the goals of the mission leaders is very important. HTT as a whole should understand what the objective of the mission is, and what effects are trying to be achieved. A clear definition of what your customer wants from you is a must. A clear understanding of your customer’s verbiage, terms, phrases, and specific military terminology is also very important. Planning starts with your understanding of your customer’s needs and goals. It must also be understood that you may not, and more likely will not, be able to completely answer all of your customer’s questions with detailed information. However, what you can do is scratch the surface, provide your customer a new perspective, bring to light something of which your customer was unaware, provide your customer with a cultural perspective, or provide your customer with recommendations to positively impact the population of an area. This list is by no means all-inclusive of what you may be able to provide a customer, but is some of the more common inputs that HTT provides.

Once you understand the needs of your customer you, **as a team**, should brainstorm the possible approaches to gathering the necessary information that will allow HTT to provide the customer with best possible product. You will also have to break down the research topics to their lowest common denominator. Remember that you can aggregate data that has been collected in the smallest possible unit, but you cannot breakdown data that has been collected in large or broad categories. For example, if you collected only the gender of your informants, and not their age you have limited your quantitative analysis potential by reducing the number of comparative units of analysis. You can only compare male to female, whereas if you had collected the ages of informants you could have compared responses by age groups (i.e. 20-25, 26-30, 31-40, etc.), which could potentially pinpoint specific trends to a specific age group.

An example: Let us look at surveying education. It would be better, quantitatively speaking, to collect the total number of years someone has gone to school, rather than simply asking: Did you graduate high school? Did you attend college? Do you hold a college degree? If you incorporate or ask: “How many years did you go to school?” and also ask any of the other questions, you have given yourself multiple comparative units of analysis. You can group the number of years and compare them for whatever, instead of only being able to compare a yes or no response.

Organizing your approach is the next step that must be considered. This is where you begin to intertwine qualitative and quantitative research methods. This mix methodology can come in many forms, and is really only limited by your creativity, and maybe your informants willingness to provide you with an answer. A bit of “standardization” in your interviewing will be necessary, but should also be transparent to the informant.

In any type of interview (unstructured, semi-structured, structured) you can ask all your informants a particular number of exact questions. For example, you can ask each informant their age, number of years of education, place of residence, and favorite color. The comparative units of analysis can be anything, but remember the smaller the unit the better. In the above example you have on the surface a minimum of four comparable units of analysis. However, in reality you have dozens. You can compare responses based on those who chose red as their favorite color to any of the other units.

You can create age categories and compare favorite colors among age groups and years of education or place of residence—or any combination of units. You could also aggregate the place of residence to county, district, state, province, or region and compare any one those to any of the age categories compared to all informants who chose yellow as their favorite color.

Now you can design your interview, regardless of the type, to always retrieve comparative units of analysis that can later be used to produce visual-statistical representations that will support and enforce your research findings and conclusions. Ask yourself, which of the following would have more impact? A report that states that young males who ate pickles for breakfast were found to have a medulla oblongata which was smaller than average, or a report that states of 100 patients that were examined, 85% of those who ate pickles with at least 33% of their breakfast meals had a medulla oblongata that was 22% smaller than the normal average size found in adult males from 20-30 years of age. Combine this with a visual-statistical representation and you have some real impact—a stand alone product.

Planning is the key to good research. Organization of your questions, research outline, research goal and choice of the type of interview is where the information gathering process begins. Having too much information is not possible; you can be selective and only use the information that directly relates to your current mission goals, and keep the remaining information for future research. The more information you have, the better the post-mission product.

Interview Techniques

There are several research techniques available, but there are a few broad categories into which these techniques fall: unstructured, semi-structured, and structured. Variations of these three techniques are virtually infinite and are only limited to your imagination. Be free. Step outside the box.

There are three things that are the most important elements of interviewing: Asking, Listening and Remembering. These three elements are certainly not the only things you must do during an interview, but if you only did these three things you could consider your session a successful interview. There may courses of action you

can take that will greatly improve the level of success for your interview. It just takes practice, the ability to accept critiques, the ability to critique yourself and the ability to learn how to improve on your shortcomings.

As a member of a Human Terrain Team, your research and “fieldwork” will be partially comprised of many techniques: participant observation, unstructured, semi-structured, etc. Additionally, much of your time gathering data will be done in a Rapid Assessment mode. Unlike traditional Anthropological research projects, we do not have the opportunity to spend a year or more in one area studying the inhabitants. Our missions will provide us anywhere from thirty minutes to a couple of days. You may have the opportunity to return to a location, but most often the reality of the situation is that you will only have the opportunity to visit a village once during a mission and only for a few hours. It is not uncommon to visit two or three villages in a single day. This translates into about 90 minutes per village and a minimum one hour of transit time to and from the village.

Even in this time-limited environment, HTT manages to use a combination of structured, semi-structured, and structured interviews, as well as Participant Observation; it all depends on what your focus is, the mission goals, and the needs of your customer, as well as the planning and organizing you did before the mission. A typical interview may also be a combination of two or three interview tasks (e.g. CPI, tribal dynamics, and powerbrokers), as well as doing a visual observation of the area and noting a simple description. Every mission you can expect to be highly occupied and engaged.

Unstructured interviews are essentially an open-ended interview and what you discover is up to you and the LKS. You begin the interview and then follow the lead of the LKS, or you can direct the LKS along a path after a topic is brought up. For example, you are interviewing a wood merchant, a job with which you are completely unfamiliar:

“Hello, my name is Tom and I work with the Human Terrain Team, which is a group that studies and learns about culture. I am interested in learning about the wood industry and what you do. Would you teach me about what you do?”

After the person agrees to be your teacher, what kind of things might you expect to hear? The answers could be any of a thousand. It is

expected that the LKS will mention things to you that will certainly need to be clarified; you may ask something like: “You mentioned one *maan*. What is that?” He would tell you that it is a common unit of measurement that is equivalent to 7 kilograms, though this may vary slightly by region. This type of interview is best used in domain discovery, learning about a subject you know nothing about, but want to categorize and understand completely. This technique will allow you to learn and understand such things as cover terms (native language), procedures, outcomes, and problems—everything about a subject or domain. This technique will also allow you to gain a framework of a domain, which will allow you to focus on particular areas of the domain. Though this technique is qualitative, you can obtain quantitative data. For example, you can learn about average daily quantity processed, sold, or shipped from a particular area. This can be compared to wood merchants in other areas. You may also be able to collect the average age of employees or daily wage/earnings, etc. There are many things you can compare. However, you must frame the question in such a manner as to obtain the quantitative data. Case in point: the wood merchant tells you that he normally ships two truck loads each day. You should clarify this answer by asking what size of trucks, and how much weight or amount each type of truck carries. What is considered a full load? These types of questions will provide you with numerical data that you can use to define and compare units of analysis. **Remember, “comparable units” of analysis are good phrases which describes product-enhancing data.**

The semi-structured interview starts with a framework of questions. This type of interview can also be used for domain discovery as a guideline for questions. Your questions can be structured in a manner that will elicit specific information about the domain you are researching. These types of questions may be included in order to expedite the domain discovery; quantitative questions can also be included. Semi-structured interviews provide an excellent means to learn about a topic (i.e. customer needs, mission priorities, etc.) rapidly. These types of interviews can be done by all members of the team that are in the field, which will further expedite the discovery as you will obviously have a larger number of participants, and thus more data. It is also important to note that an “*n*” (number of participants/respondents) of 30 is considered to be a valid statistical quantity for saliency, or prominence, among a population. That is to say that if you interview 30 random people, their responses can be

considered statistically sufficient to identify trends, patterns, and correlations among a population. Even though $n=30$ is considered statistically relevant, meaning that you can use this as a basis for projection, estimation, etc, a larger n is better and will provide more accurate results. Consider an $n=30$ for a population of 100 versus $n=30$ for a population of 5,000. Obviously, the first n quantity will be more representative of the entire population than the second n size.

Structured interview is essentially a survey. There are some instances where survey format is necessary, especially with the limited time we often have in an area. Structured interviews are typically employed in order to obtain information about a specific topic in a particular format. Keep in mind that structured interviews leave no room for deviation and do not allow the respondent to speak freely about what is most important to his or her at that moment. For example, you may want to gather information about the wood industry and the respondent is answering your questions, but he is also telling you about recent hardships in the village. Which is more important? What do you do? In my opinion it is a matter of time. If you have enough time, tell him that you would love to talk about the hardships because they are important and that you have enough time to talk about that after you learn about the wood industry. Or maybe you decided his posture simply demands that you learn about the hardships. Which topic would have more meaning for the mission? Maybe no one has any idea about the hardships this village is experiencing. You will have to determine how to handle the situation best.

Each village and population is different, as is each mission. You can do some things every time you arrive at a location or ask “standard” questions every time in order to obtain comparable units of analysis, but sometimes the LKS will cause you to deviate from your research plan, taking you down an unexpected path where you will learn about something that is highly salient or simply a point of contention. The beauty of this is that you are virtually unlimited in your areas of study; you are in the field to learn about those topics that are of interest to the customer, but they may not be aware of all the things that could be of interest to them.

Field notes

Field notes are not merely a motion you go through while you are in the field; **field notes are everything!** While there is not a single, correct method for writing field notes, there are some key methods to structure your notes that will aid in the coding, analyzing, and pulling information from your field notes in order to draft final products.

First, field notes are **your** field notes and you write them in whatever manner you wish; you and you alone will have to be able to decipher them at the end of the mission. Coding allows the element of anonymity; the names of your LKS should not be written anywhere in order to protect that person's identity. There is an exception to this rule, which applies to public officials as LKS. Since their names are already known and the subject is not controversial, it is considered practical to use their real names. This is the only exception.

The next item to consider is structure. There are several items that aid in drafting the post-mission reports, as well as developing an assessment of an area. One is the acronym **SPIIE OP**; this construct highlights the minimum information we would like to compile and overall focus for each village. There are additional village-focus topics for which you should gather information, but these are more specific in nature.

SPIIE OP (Security, Population, Infrastructure, Issues/Friction points, Economy, Opportunities for Engagement, Perceptions/interactions)

Security: Research the security situation. Ask everyone you talk to about the security situation and how it is compared to last year. Find out why it is better or worse than last year. Ask for examples.

Population: Observe the population. See how they are dressed and the state of their clothes. Look at their general state of health. Look at the men, women and children present. Are there a lot of children? Are the women that you see pregnant? Ask for the tribal information. From what tribe is the informant? What is the tribe composition of the village? Which other villages in the area are of the same tribe? With which villages do they interact and why? Any disputes? How do the residents live? Do they farm? Do they raise animals for consumption and/or sale?

Infrastructure: Look at the houses. Observe how the houses are built; Are they single-floor homes? Do they have a security wall? How are the homes built? Are they large? Do they have windows? Are there shutters? Is paint used? What is the security gate like? Metal? Decorated? Are there signs of prior NGO activities? Types of animals. Electricity? Wells? Irrigation?

Issues/friction points: Discover if there are prior or existing issues with the Coalition Forces, Local Army, Local Police, other tribes, within in the tribes, other villages, etc.). Discover if there are past incidents with the Coalition for which the residents harbor any malcontent.

Economy: Discover the primary source of income. Out-of-country employment? Are there a lot of men who work out side of Afghanistan? Where? Does the village grow enough food to sell or trade, or do they only grow enough for their own subsistence? Do people have to borrow money? How much? How often? What are the terms and consequences of the loan? From whom do they borrow money? From where does that person(s) money come?

Opportunities for engagement: Look for ways that things can be improved. Look for economic opportunities or projects the government can bring that will benefit the greatest number of people. Quick impact projects? Long-term sustainment projects?

Perceptions/interactions: Discover how people feel about things in the village, area or in the government. Try to find out how they feel about the Coalition and local forces. How do they perceive things to be compared to last year? Better? Worse? Why?

It will be very helpful in post-mission activities to keep SPIIE OP in mind while writing, organizing and processing your field notes. It will to input your field notes into the Field Notes Database much easier. It will also allow you to organize your notes by themes, which will also assist with analysis. This process is by no means mandatory, but is merely suggested as a guide that will help ease the pain of post-mission processing of field notes, as well as ease of analysis and product development.

Each category of SPIIE OP is meant to be the large umbrella topic, which is then followed my specific sub-categories. Also, SPIIE OP was created as a way to collect the same information about each location visited in an effort to develop current snapshots, as well as

historical information that can be used for comparison as a means to develop a more in-depth understanding of an area, district, or province. The information can also be used as a baseline and thereby become a gauge to track change in an area.

Finally, SPIIE OP is a multi-purpose tool for HTTs to collect information in a semi-structured manner. It is meant to act as starting point for gathering information that will produce a broad brushstroke and a refined micro-level view, depending on data and the refinement, analysis, correlation and collation thereof. This tool also offers a way to “task” ourselves when we get boots-on-the-ground. It is impossible to believe that one person, in a brief period of time, can collect enough data about every location in order to draft a representative snapshot. However, by task organizing we can break up the responsibilities and allow for more focused research at each location. You will most likely gather more information than you originally set out to gather, but that is the nature of the beast. By having an idea about what to gather, you should be able to use this as a springboard and a means of finding topics to “drill down” for more in-depth information.

“Drilling down”

Drilling down is a term for delving deeper in an effort to discover the root basis of a matter. The analogy is much like someone looking for a treasure. You begin your adventure or discovery mission with a map, or basic idea, of where you are going and what you want to find. Once you arrive at your location, you examine the environment and scratch the surface. Then you discover clues and lead you to start digging deeper.

There have been many instances where HTTs have realized that an opportunity to drill down and possibly discover a spectacular nugget was missed. Most of the time it was simply the team member focusing too much on one particular topic to notice the opportunity. How do you know you missed a nugget-discovery opportunity? Usually you learn of your missed opportunity later that evening or even days later when you are reviewing your notes or recorded interview. Improve your technique by reviewing your interviews (notes and recordings) and learning from these missed opportunities.

In order to capture these opportunities when they arise you can use several techniques. One technique is a *descriptive questioning* approach, which could possibly involve using *specific* or *guided* Grand-tour questions. Or you can use *specific* or *guided* Mini-tour questions.⁹ You can employ one or a combination of these techniques in order to have your LKS uncover the information, institutionalizing the knowledge.

Spradley's Taxonomy of Ethnographic Questions

1. Descriptive Questions
 - Grand Tour Questions
 - Typical Grand Tour Questions
 - Specific Grand Tour Questions
 - Guided Grand Tour Questions
 - Task-Related Grand Tour Questions
 - Mini-Tour Questions
 - Typical Mini-Tour Questions
 - Specific Mini-Tour Questions
 - Guided Mini-Tour Questions
 - Task-Related Mini-Tour Questions
 - Example Questions
 - Experience Questions
 - Native-Language Questions
 - Direct Language Questions
 - Hypothetical-Interaction Questions
 - Typical-Sentence Questions
2. Structural Questions
 - Verification Questions
 - Domain Verification Questions
 - Included Term Verification Questions
 - Semantic Relationship Verification Questions
 - Native-Language Verification Questions
 - Cover Term Questions
 - Included Term Questions
 - Substitution Frame Questions
 - Card Sorting Structural Questions
3. Contrast Questions
 - Contrast Verification Questions
 - Directed Contrast Questions
 - Dyadic Contrast Questions
 - Triadic Contrast Questions
 - Contrast Set Sorting Questions
 - Twenty Questions Game

⁹ Refer to "Spradley's Taxonomy of Ethnographic Questions" developed from Spradley's "The Ethnographic Interview", 1979.

Working with Interpreters

Working with interpreters can be a very challenging endeavor, which can lead to a great interview or leave you filled with frustration. There are several things that you should consider before working with an interpreter: pre-brief, field activities, voice tense and your own sentence structure. All affect the success or failure of your interview. As with everything else, practice makes perfect and if you have not worked with an interpreter before, you practice as much as possible before going to the field.

Interpreter Pre-brief

This is the foundation of your interview. How do you feel being thrown into a situation without the slightest clue of what is about to occur? Your interpreter is no different. Pay them the courtesy of explaining to them what it is you are wanting to ask, how you are going to ask it, the importance for accurate and unbiased translation from them, as well as setting the tone of the interview. The more your interpreter knows about what you are trying to achieve or acquire, the more they will be able to assist you in that endeavor. This will allow them to prepare for the mission. The first time your interpreter sees the questions you want to ask should not be in the field. That should be done at prior in order to discover if you are asking the right questions in order to solicit the information you desire, or if the question is being asked correctly. A small example is when asking about powerbrokers. We, as Americans, have the tendency to ask “who is the most powerful person” in order to discover who the important people are in the area. However, the more culturally appropriate question might be “Who is the most important person in the area?” Culturally, *importance* is synonymous with *power*, but not vice versa. **It is a good idea, regardless of your background or experience to ask the interpreter if the questions are framed and being asked correctly.** This simple step will save you much frustration and disappointment. Once you have run the potential questions past the interpreter try interviewing FOB workers. This serves four purposes: interview practice, testing your questioning, work more with the interpreters and gathering data from our local population.

In the field

Once you arrive at your mission area, you should again brief the interpreters about what is going on and inform them of any changes that may have occurred. You should also review the mission with them, as it may have changed. You should also review and adapt your security and mission plans, as they will probably need to be modified.

Interviewing

Once you arrive at your mission location (inside or outside the wire) you are off to the races. However, team security and integrity are extremely important. Follow your plan as best you can. Be warned, you will have to adapt to the changes and the environment. Once you link up, set off on your mission. When you find your first LKS introduce yourself and explain who and what you are. The interpreters should have worked out a good way of explaining this. If not, describe it as a cultural study team that is working with the Coalition in order to better understand the local population. We are students and want to learn as much about the cultural as possible. We are also teachers and must take the cultural information we receive and teach the Coalition, including the local security forces what we learned. This usually sets a good tone. You should also ask permission to take notes, record and/or take any photos prior to doing so. Provide an explanation as to why you want to do these things. People usually do not have a problem with these actions, but occasionally someone will decline your request. That is when you must rely solely on your memorization skills.

Be fluid, pay attention to the answers you are receiving, be mindful of opportunities and structure your questions succinctly and clearly. The latter is extremely important. If you get a funny look from the interpreter, or he asks "Is that a question?" you should stop, determine what you are asking and ask it in simpler terms. This is to alleviate the chance for deviation and confusion on the part of the interpreter as well as the LKS. You must pause between thoughts in order to give your interpreter an opportunity to translate your statements, as well as any responses for the LKS. **Pause, and let them translate, so they can convey your message as completely and accurately as possible.** This adds time to the interview and will certainly take a conscious effort on your part, but it will prove more fruitful.

Have the interpreter translate things in the 1st person. This changes the tone of the interview in many ways. It gives the interpreter a place of importance, makes things less confusing and is more active, adding a more agreeable and personal tone on the conversation.

Elements of Ethnographic Interview

Spradley's Elements in the Ethnographic Interview

1. Greetings
2. Giving ethnographic explanations
 - 2.1. Giving project explanations
 - 2.2. Giving question explanations
 - 2.3. Giving recording explanations
 - 2.4. Giving native language explanations
 - 2.5. Giving interview explanations
3. Asking ethnographic questions
 - 3.1. Asking descriptive questions
 - 3.2. Asking structural questions
 - 3.3. Asking contrast questions
4. Asymmetrical turn taking
5. Expressing interest
6. Expressing cultural ignorance
7. Repeating
8. Restating informant's terms
9. Incorporating informant's terms
10. Creating hypothetical situations
11. Asking friendly questions
12. Taking leave

Example Taxonomy

Domain diagram

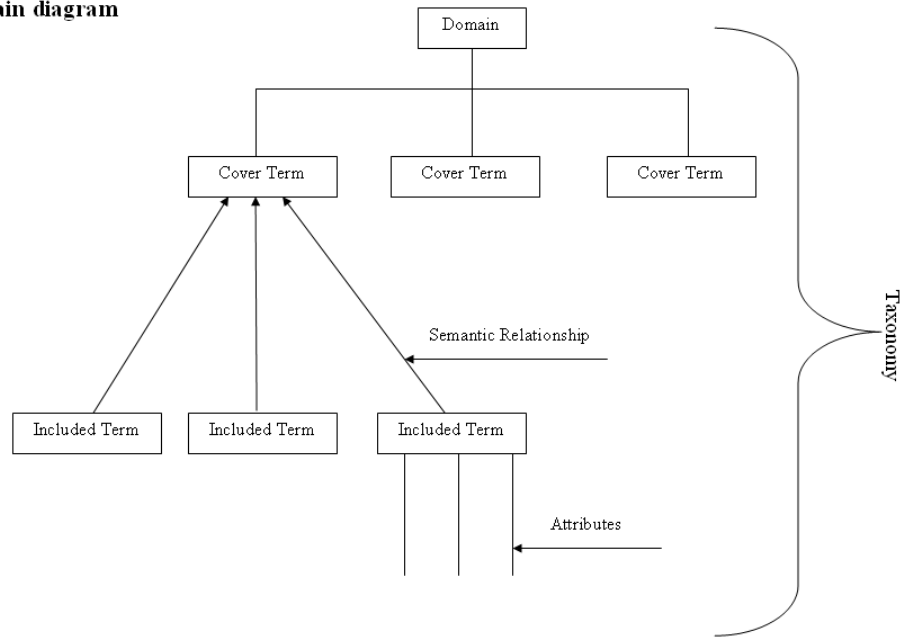

Domain Analysis Worksheet

1. **Semantic Relationship:**
2. **Form:**

Included Terms		Semantic Relationship	Cover Term
		is ... 	Term

Interaction with the Reachback Research Center¹⁰

Requests for Research

A well-constructed Request for Information (RFI) greatly increases the efficiency of getting the requirement to the proper individual(s) to provide the quickest and highest quality response to the customer. For that reason, the amount of time spent in developing a well-constructed requirement is time well spent in the overall process.

Below are some characteristics of a well-written requirement and are key in developing an RFI.

- Select a subject that clearly represents the content of the requirement at the lowest classification possible (preferably unclassified).
- Clearly delineate what the requirement is. Refine the scope and magnitude to the true need of collection by a specific intelligence source.
- Provide prioritization when multiple related items are requested.
- Create separate RFIs/ Production Requests (PRs) for different subjects and/or countries. Avoid RFIs/PRs with multiple unrelated tasks.
- After a RFI/PR has been validated, it is encouraged that you clarify any existing ambiguities.
- State the justification of/purpose for the request for information. This is an essential element of the requirement. Justification/purpose should reveal how the intelligence will be utilized. A good justification needs to include, but is not limited to, the operation or exercise being conducted, why this information is needed, time frames, and how the intelligence is going to be used.
- Provide background to the RFI/PR and do not assume that a production center knows everything or has readily available access to the most recent versions of documents.
- List sources reviewed prior to RFI/PR submission and state specifically why those sources did not meet the requirement. Ensure that you have checked all logical sources.

¹⁰ Based on the Reachback Research Center SOP, July 2008.

- Provide a realistic and reasonable suspense. Include the latest date the information will be of value.
- If coordination has already occurred with specific analysts (especially important on short-fused requirements), provide the name and phone number of the person who the coordination occurred with, along with the name of the person who contacted them.
- Provide a point of contact for the RFI/PR. Indicate the names, phone numbers, and e-mail addresses for both the RFI Manager and the customer.
- Include the highest classification of the product that is acceptable to the customer.

Submission of Information/Products

Request for Research (RFR) Procedures and Responsibilities

An RFR is transmitted to the RRC via email (JOLV_HTS_RRC_IR_Mngr@jricp.osis.gov). It is the responsibility of the information management officer (IMO) on duty to acknowledge receipt of the RFR to the requesting HTT and the IR Manager-group email account in Outlook in a short and concise statement (e.g. “The RRC acknowledges receipt of your RFR. Once reviewed an RFR number will be assigned to it and released to you as soon as possible, thank you.”).

An RFR number is assigned to the RFR once the IMO and analyst on duty reads and approves the RFR for research. Once the RFR is approved for research the IMO will then assign an RFR number to the RFR and email that number to the requesting HTT.

Methodology of the RFR numbering system.

- RFR’s are numbered by the following steps:
- First part contains the acronym RRC.
- Next the HTT team name e.g. IZ1.
- Next the last 2 digits of the year e.g. 07 for 2007.
- Finally add the next sequential number up in 4 digits e.g. 0001, 0002, 0003. Each part, except for the last part, is followed by a hyphen. An example of a correct RFR number is as follows: RRC-IZ1-07-0001.

Once a product has been completed, reviewed, and released by lead analyst, the analyst must inform the IMO on duty via email that the product is ready to be sent forward to the HTTs. Regardless of the requesting HTT the product is sent out to all HTTs in the country of interest of the product. The document that the IMO is to disseminate via email to the HTTs is the PDF version of the product.

HTT Produced Products Procedures and Responsibilities

HTTs periodically send to the RRC products they have begun and/or finished in country. These products are sent to the RRC via email. Once received it is the responsibility of the IMO on duty to acknowledge receipt of the product to the sending HTT in a short and concise statement (e.g. “The RRC acknowledges receipt of your product/products, thank you.”).

All deployed HTTs have a “Team Produced Products” folder on the HTS SharePoint. All products will be added to these folders.

The deployed HTTs send out weekly SITREPS to the RRC. It is the responsibility of the IMO on duty to acknowledge receipt of the SITREP to the sending HTT in a short and concise statement (e.g. “The RRC acknowledges receipt of your SITREP, thank you.”).

Appendix A

Best Practices of an HTT

“The greater part of mankind are so narrowly and so complacently satisfied with their own standpoint that it never occurs to them to imagine themselves in other men’s positions, or to endeavor to analyze their motives. What a different world it would be if we all did so!” - Sir John Bagot Glubb (Glub Pasha),
War In The Desert 1960

Team Best Practices

- Be the Commander’s Cultural Advisor. The key must be to not only have sufficient cultural expertise but also have the necessary research capability to convert data and information into *knowledge* that can be leveraged by the unit.
- The team speaks with “One Voice.” Unity of effort and purpose prevents misunderstanding with both the supported unit, and the local population.
- Always keep a member of the team tied into the staff. This will allow the team, when focused on research outside the planning processes, to keep a pulse on what is important to unit and plan/resource the next mission.
- Provide focused study on social science, cultural or ethnographic issues of specific concern to the Commander by conducting social science research that adhere to the ethics of Anthropology and Sociology. Insure the team completes the full cycle of Research, Debrief, Analyze, Document.
- Be an effective sensor for data collection from tactical patrols, key leader engagements, individual interviews, other interactions with the populace, open source foreign media, and other general atmospheric collection.
- Identify and assess friendly information below the UNIT level, disseminating to everyone in order to facilitate cross-

talk. This applies from battalion to brigade, but even more importantly across borders between adjacent battalions.

- Create UNCLASSIFIED//FOUO products so that everyone can observe and understand the human terrain.
- No Lethal Effects Targeting. The commander has an intelligence section for lethal targeting, what they require is a section that can explain and delineate the non-lethal environment (e.g. tribal relationships and local power structures), as well as the second and third order effects of planned lethal and non-lethal operations.
- Be accurate, relevant, and concise. If you are not accurate, you will not get a second chance. If you are not relevant, then you will be marginalized within the staff. If you are not concise, no one will make time for your expertise.
- Protect the Commanders' time. The commander does not have time for dissertations or long lectures. Give him what he needs, and only what he needs, in the quickest manner possible.

Fieldwork Best Practices

- Conduct a thorough cost-benefit analysis of needed research to accurately select those most effective at supporting the commander, staff, and subordinate units' needs.
- Create collaborative decision-making. After talking with the party requesting research or deciding on a topic for research, each member should comment on what they believe the unit requires. This collaboration works best by asking the quietest person's opinion first, to insure all viewpoints are heard. Based on this discussion, the team can then collectively decide on prioritization for the research. From this develop research questions and utilize local nationals to vet them and insure they are eliciting the answers desired. Following the mission, the team brings the data together and analyzes it, followed by a discussion of what each team member thinks

the research is indicating, again with the quietest person starting the discussion.

- Enable the HTT Analyst to engage in unconstrained, open-ended conversation. The best information is gathered during informal discussions that start with relationship-building and is controlled by the interviewee with limited focusing from the analyst.
- Enable the HTT Analyst to observe the interactions between Coalition Forces and the local population. One of the largest impacts the HTT can have is informing friendly forces how they can better culturally interact with the locals.
- Do not burden the Analyst with interpreter duties. Human terrain collection will be significantly degraded if the Analyst's focus is dedicated to this taxing task.
- Avoid direct involvement in tactical questioning. Tactical questioning is a function of the intelligence world and designed to elicit primarily lethal-targeting information. It would also endanger relationships with the local population if HTTs are seen being involved with the "interrogating" of friends/family.
- Provide detailed analyses of individuals, the social environment, and social structure of the area of operations. These are the key human terrain data points that can effect unit planning, operations, and key leader engagements. Facilitation of the relationships between the unit and cultural leaders is key.
- In order to optimize feedback and accurately address the research questions, the HTT needs:
 - Proper introductions and continued access to local power brokers and other persons of interest,
 - Local and unit support for engagements with persons of interest, local informants and the general public.

Effective Research Topics

- I. Determine tribal, religious, former regime, and ISF influencers through:
 - Examination of Brigade and Battalion historical records
 - Developing perceived hierarchy and tribal structures of the area of operations and areas of influence
 - Developing individual biographies of local power brokers
 - Identifying and collecting required human terrain information pertinent to the research design
 - Continuing to refine individual biographies and perceived hierarchies
 - Determining overlapping influencers

- II. Identify key sources of influence and power brokers and then analyze the relationships affecting the local social groups, civil, military, tribal, religious and informal leaders.

- III. Determine political, cultural, and religious pressure points and influencers in order to enable selection of non-lethal engagements and effects that can positively influence the local population, culminating in a possible Engagements Strategy to be integrated into the IO section.

Products

HTT products are developed through analyzing and synthesizing human terrain data gathered both in the field and through debriefs/interviews. Products are the documentation of the team's human terrain knowledge of specific topics that are of particular concern to the unit, or should be. Together with input to working groups, this is the primary input to the human terrain portion of the commander's Common Operating Picture. The primary customers of HTT products are the commander, deputy commander, S3, S2 (for situational awareness), PRT, CA, PSYOP, IO, and Reconciliation Officer. Products are disseminated primarily through email and placing on the unit's SIPR portal, but should also be followed up with discussion and briefings to insure understanding by the unit and inclusion into planning.

I. Assessments

Cultural Assessment

An assessment done by an HTT to acquire a more robust socio-cultural, political and economic awareness of a research area in order to provide friendly forces with operationally relevant information to better understand the human terrain. The objectives of the assessment are set out by the team, in consultation with the requesting agency, to add depth to the existing tribal map of the research area, identify tribal friction points, economic opportunities and constraints, perceptions of the government, key influencers, levels of corruption and avenues for dispute resolution.

Information Operations (IO) Themes

Effective information operations require an extensive and intimate familiarity with the target culture. The HTT is often approached with requests to review or devise themes that are culturally accurate, meaningful, and effective. More often, though, the team will have myriad ideas for themes beyond the solicitation of the unit. Ideas for these themes will surface in meetings, among review of media, observing soldiers' interaction with the local population, assessing locally-generated PSYOP products, etc. The HTT should be vigilant in the course of their information gathering and record information that could be useful to the unit's IO efforts.

Media Assessments

The media provides a great deal of information that can be exploited for greater situational awareness. Assessing trends in the media provides the unit a longitudinal view of events in the region that they don't normally have the time and means to exploit them. Tracking these themes and occurrences allows the HTT a broader temporal view of events and the ability to place other local events in a more accurate context.

II. Informational

Internally-Generated Reports

For matters pertaining to culture and counterinsurgency (or nation building, peace keeping, occupation, advising; whatever the nature of America's involvement may be), some units don't have as firm a grasp as others. Frequently the HTT will have enough situational awareness and cultural expertise to recognize deficiencies in the unit's overall picture. Individuals and individual branches are normally so busy keeping up with the information pertaining directly to their line of operation that they rarely have the time or means to fuse information the different branches into one cell of culturally astute subject matter experts. The HTT is in a unique position to bridge this gap. The team will be able to ask the questions that the unit doesn't think to ask or think needs asking. These assessments provide the unit with additional expertise and a certain degree of quality control. Review of unit products, proposed courses of action, local information operations, local opinions, rumor, regional media themes, and matters that arise in unit meetings that the Team Leader deems amenable to HTT contribution are all possible avenues of unsolicited assistance.

Reachback Research Center Reports

Frequently, other HTTs will require research from the RRC that will apply to their own area of operations. Without significant effort, these RRC reports can be adapted to the HTT's respective area for the benefit of the unit they are supporting. Other teams may ask questions and pursue issues that another team didn't consider, but that bears full relevance to their own area. Many issues pertain to regions consisting of several HTTs and the information gathered and tailored to one HTT's operating environment, with minor adjustment, can be easily applied to another. Drafting Executive Summaries (EXSUMs) of RRC reports is another means by which the team can supply the unit with information they may not have considered requesting, but that would be a worthwhile contribution.

Media Summaries

In the course of maintaining current situational awareness through review of the media, unit's could benefit from a summary of the

items that have direct or indirect relevance to the area of operations or that might provide information on issues or events that the unit's may encounter on their patrols or in intelligence traffic. These items allow the unit to place these references in a more accurate context.

Biography

A biography describes a subject's life story, ideology, loyalties, beliefs, genealogy, etc. This report is usually done to inform the Commander and staff of a particular local leader of which they should be aware. A biography is usually associated with a Key Leader Engagement or other governance-involved meeting.

III. Review for Cultural Impact and Relevance

Cultural Knowledge Report

This report is an explanation and analysis of a social or cultural fact that is requested by the unit or the HTT feels the unit needs to be aware of (e.g. conflict mitigation strategies in the local culture, upcoming religious/cultural holidays, etc.).

It can include a vignette that illustrates the cultural facts that affect the battle space and/or operations.

Trip Reports

HTTs will make useful observations in the course of gathering information for their research endeavors in among the indigenous population. These observations will, in turn, spawn further considerations for research and advisement. Trip Reports provide a vehicle to convey these observations to the supported unit. The following is a list of observations that could be considered for inclusion in Trip Reports:

- Cultural observations
- The unit's interaction with the local population
- Observations of the behavior of American forces
- The reaction of the indigenous population to the presence of American forces
- Status of the infrastructure
- Host nation security presence
- Host nation government produced PSYOP products

- PSYOP products produced by extremist groups
- SoIs encounters and engagements
- Analysis
- Pictures

Significant Dates and Events

It is imperative that the unit be familiar with the nature and dates of locally celebrated holidays, commemorations, and memorials in order to understand the social aberrations that attend them (empty/crowded streets, increased/decreased traffic, increased violence, increased/decreased gunfire, changes in movement of residents, increased/decreased foot traffic, processions, seemingly bizarre behavior, increased/decreased purchase of certain foods, movement throughout town and across international borders, increased/decreased tourism, increased presence at centers of worship, changes in daily patterns, increased use of electricity, etc.) These occasions often come and go with very little consideration for exploiting their potential advantages. Helping the unit understand these occasions will expand their possibilities and provide additional means of positively and appropriately engaging with the local population, and avoiding inappropriate engagement with the local population. The HTA should preempt these events and celebrations with assessments to the unit about what could be expected.

IV. Interpretation of Events

Executive Summary

A brief report used to quickly display key points and important trends/themes. Usually in a bulletized format and designed to lead the reader in to a more in depth report when time allows.

Spheres of Influence (SoIs) Engagement Reports

In the course of their information gathering, HTTs will encounter individuals in the local population that exert some degree of influence in their respective society, and with whom American units will wish to engage to advance their cause. Teams will want to record these encounters for dissemination and continuity. Identification, affiliations, associations, the nature of the conversation, matters discussed, the location of the engagement, and how the information

might help the unit should be recorded and disseminated to individuals and branches that would benefit from the information. This information will also help the HTA establish social networks and SoI tracking documents for the unit.

Engagement Debrief Report

Based on a specific meeting or event (i.e. Commander's Key Leader Engagement, DAC/NAC meeting, etc.)

The report is based on a human terrain analysis of cultural cues that occurred during the engagement and is in a narrative format. This narrative format includes a brief Executive Summary that highlights key points that address pertinent issues, with explanation and deeper analysis of each point should the reader have more time or need more information.

Effective Tasks and Purpose

T: Assess Intercultural differences and dispel any misconceptions

P: Assist in improving unit operations amongst the local populations

P: Prevent unnecessary friction between the unit and local populations

T: Assist in establishing a coherent, analytical framework for operational planning, decision-making, and assessment pertaining to human terrain

P: Enhance mission analysis through the input of relevant human terrain information

P: Enhance COA development through the input of relevant human terrain information

P: Enhance COA analysis with possible second and third order effects of each option

P: Enhance assessment through a review of the measures of effectiveness and measures of performance.

T: Observe Sphere of Influence engagements

P: Passive collection of socio-cultural data

P: Assess engagement procedures for possible adjustment

P: Collect specific observations

- T:** Observe unit operations amongst the population
 - P:** Passive collection of socio-cultural data
 - P:** Observe interactions between soldiers and the local population
 - P:** Collect area specific observations
 - P:** Collect TTP specific observations

- T:** Interview the local population
 - P:** Collect local genealogies/hierarchies
 - P:** Collect socio-cultural data
 - P:** Collect non-lethal engagement data

- T:** Address unit Requests for Information
 - P:** Provide detailed background information
 - P:** Provide reliable statistical data
 - P:** Provide reliable anecdotal data
 - P:** Provide analysis and feedback of requested information

- T:** Enhance socio-cultural knowledge during target and effects analysis
 - P:** Predict target behavior / response through second/third order effects analysis
 - P:** Identify both negative and positive unintended effects of operations

- T:** Provide feedback
 - P:** Identify gaps in Sphere of Influence and local population engagements
 - P:** Identify effects (positive and negative) on the local population of unit Tactics, Techniques and Procedures
 - P:** Identify non-governmental (tribal/traditional/informal) power structures and their effects/influence

Appendix B

Briefing

How to Effectively Brief

Periodically the team must communicate information to commanders and staffs through military briefings. Briefings are a means of presenting information to commanders, staffs, or other designated audiences. The techniques employed are determined by the purpose of the briefing, the desired response, and the role of the briefer. This tab describes the types of military briefings and gives briefing formats for each type. There are two types of military briefings that are used by an HTT: Information and Staff.

Information Briefing

The information briefing is intended to inform the listener and to gain his understanding. The briefing does not include conclusions and recommendations, nor require decisions. The briefing deals primarily with facts, and provides information in a form the audience can understand. The briefer states that the purpose of the briefing is to provide information and that no decision is required. The briefer provides a brief introduction to define the subject and to orient the listener and then presents the information. Examples of an information briefing are information of high priority requiring immediate attention; information of a complex nature, such as complicated plans, systems, statistics, or charts, requiring detailed explanation; and controversial information requiring elaboration and explanation.

- 1. Introduction**
 - a. Greeting.** Address the audience. Identify yourself and your organization.
 - b. Type and Classification of Briefing.** For example, "This is an information briefing. It is classified SECRET."
 - c. Purpose and Scope.** Describe complex subjects from general to specific.
 - d. Outline or Procedure.** Briefly summarize the key points and general approach. Explain any special procedures (such as, demonstrations, displays, or tours). For example, "During my briefing, I'll discuss the six phases of our plan. I'll refer to maps of our area of operations. Then my assistant will bring out a sand table to show you the expected flow of battle." The key points may be placed on a chart that remains visible throughout the briefing.
- 2. Main Body**
 - a. Arrange the main ideas in a logical sequence.
 - b. Use visual aids to emphasize main ideas.
 - c. Plan effective transitions from one main point to the next.
 - d. Be prepared to answer questions at any time.
- 3. Closing**
 - a. Ask for questions.
 - b. Briefly recap main ideas and make a concluding statement.
 - c. Announce the next speaker.

Figure 11 - Format for an Information Briefing

Staff Briefing

The purpose of a staff briefing is to coordinate unit efforts by informing the commander and staff of the current situation. The person who convenes the staff briefing sets the agenda. Staff representatives each present relevant information from their functional areas. Staff briefings may involve exchange of information, announcement of decisions, issuance of directives, or presentation of guidance. They may have characteristics of information briefings, decision briefings, and mission briefings.

Attendance at staff briefings varies with the size of the headquarters, type of operation, and commander's preferences. Generally, the commander, deputies or assistants, chief of staff (executive officer), and coordinating and special staff officers attend. Representatives from major subordinate commands may be present. The chief of staff

(executive officer) usually presides. The commander usually concludes the briefing but may take an active part throughout it.

In garrison or on an extended deployment, staff briefings (sometimes called “staff calls”) are often regularly scheduled. In combat, staff briefings are held as needed. The presentation of staff estimates culminating in a commander’s decision to adopt a course of action is a form of staff briefing that incorporates aspects of a decision briefing. In this type of briefing, staff representatives use the staff estimate for their functional area as an outline.

Format for a Staff Briefing
1. General
a. The staff briefing is a form of information briefing given by a staff officer. Often it is one of a series of briefings by staff officers.
2. Purposes of a Staff Briefing
a. The staff briefing serves to keep the commander and staff abreast of the current situation.
b. Coordinate efforts through rapid oral presentation of key data.
3. Possible Attendees
a. The commander, his deputy, and chief of staff
b. Senior representatives of the primary and special staff; commanders of subordinate units
4. Common Procedures
a. The person who convenes the staff briefing sets the agenda.
b. The chief of staff or executive officer normally presides.
c. Each staff representative presents information on his particular area.
d. The commander usually concludes the briefing but may take an active part throughout the presentation.

Figure 12 - Format for a Staff Briefing

Briefing Steps

Briefings have four steps:

1. Analyze the situation. This includes analyzing the audience and the occasion by determining:
 - Who is to be briefed and why?
 - How much knowledge of the subject does the audience have?
 - What is expected of the briefer?
 - Before briefing an individual the first time, the briefer should inquire as to the particular official's desires. The briefer must understand the purpose of the briefing. Is he to present facts or to make a recommendation? The purpose determines the nature of the briefing. The time allocated for a briefing will dictate the style, physical facilities, and the preparatory effort needed.
 - The availability of physical facilities, visual aids, and draftsmen is a consideration. The briefer prepares a detailed presentation plan and coordinates with his assistants, if used. The preparatory effort is carefully scheduled. Each briefer should formulate a "briefing outline." The briefer initially estimates the deadlines for each task. He schedules facilities for practice and requests critiques.

2. Construct the briefing. The construction of the briefing will vary with its type and purpose. The analysis provides the basis for this determination. The following are the major steps in preparing a briefing:
 - Collect material.
 - Know the subject thoroughly.
 - Isolate the key points.
 - Arrange the key points in logical order.
 - Provide supporting data to substantiate validity of key points.
 - Select visual aids.
 - Establish the wording.
 - Rehearse before a knowledgeable person who can critique the briefing.

3. Deliver the briefing. A successful briefing depends on how it is presented. A confident, relaxed, forceful delivery, clearly enunciated and obviously based on full knowledge of the subject, helps convince the audience. The briefer maintains a relaxed, but military bearing. He uses natural gestures and movement, but he avoids distracting mannerisms. The briefer's delivery is characterized by conciseness, objectivity, and accuracy. He must be aware of the following:
 - The basic purpose is to present the subject as directed and to ensure that it is understood by the audience.
 - Brevity precludes a lengthy introduction or summary.
 - Logic must be used in arriving at conclusions and recommendations.
 - Interruptions and questions may occur at any point. If and when these interruptions occur, the briefer answers each question before proceeding or indicates that the questions will be answered later in the briefing. At the same time, he does not permit questions to distract him from his planned briefing. If the question will be answered later in the briefing, the briefer should make specific reference to the earlier question when he introduces the material. The briefer must be prepared to support any part of his briefing. The briefer anticipates possible questions and is prepared to answer them.

4. When the briefing is over, the briefer prepares a memorandum for record (MFR). This MFR should record the subject, date, time, and place of the briefing and ranks, names, and positions of those present. The briefing's substance is concisely recorded. Recommendations and their approval, disapproval, or approval with modification are recorded as well as any instruction or directed action. This includes who is to take action. When a decision is involved and doubt exists about the decision maker's intent, the briefer submits a draft of the MFR to him for correction before preparing it in final form. The MFR is distributed to staff sections or agencies that must act on the decisions or instructions contained in it or whose operations or plans may be influenced.

Sample Capabilities Brief

HUMAN TERRAIN TEAM



**Sample
CAPABILITIES BRIEF**

HUMAN TERRAIN TEAM

TOPICS

- *Team Composition*
- *HTT Mission Essential Tasks*
- *Mission*
- *Capabilities*
- *Areas of Focus*
- *Population Influences*
- *HTT— BCT Integration*
- *Information Collection*
- *Research Methodology*
- *Village Assessments*
- *Logistical Requirements*

HUMAN TERRAIN TEAM

TEAM COMPOSITION

Team Leader:

Social Scientist:

Social Scientist:

Research Manager:

Research Manager:

Human Terrain Analyst:

Human Terrain Analyst :

Human Terrain Analyst :

Human Terrain Analyst :



HUMAN TERRAIN TEAM

HTT ESSENTIAL TASK LIST

I. Conduct a Cultural Preparation of the Environment (CPE)

- Design a Human Terrain Research Plan.
- Integrate cultural research activities ISO BDE objectives
- Conduct Rapid Ethnographic Assessment Protocol (REAP)

II. Integrate Human Terrain into the Military Decision Making Process

- Develop the Human Terrain Collection Plan.
- Develop Human Terrain information requirements.

III. Provide Human Terrain Support to Current Operations

- Identify cultural decision / adjustment points that impact the population
- Develop recommended popular responses or mitigating strategies to gain or maintain support of the local populace
- Maintain the Human Terrain Component of the BDE's Common Operating Picture (COP)

IV. Evaluate Human Terrain Effects:

- Friendly and enemy operations on the human terrain
- Human terrain on friendly and enemy operations



HUMAN TERRAIN TEAM

HTT MISSION STATEMENT

Conduct *operationally-relevant*, open-source social science research, and provide commanders and staffs at the BCT/RCT and Division levels with an embedded knowledge capability, to establish a coherent, analytic cultural framework for operational planning, decision-making, and assessment.



HUMAN TERRAIN TEAM

HTT CAPABILITIES

1. Embedded Expertise

- Develop academic frameworks to analyze people, culture, events, and society
- Regional research and analysis

2. Field Research

- Deploy embedded in BCT organic assets (PRT, CA, Maneuver Elements, etc.)
- Non-lethal focus on cultural and socio-economic indicators
- Apply framework to gather information

3. Research Reach-Back Cell

- In-Depth, remote research assistance (CONUS based)



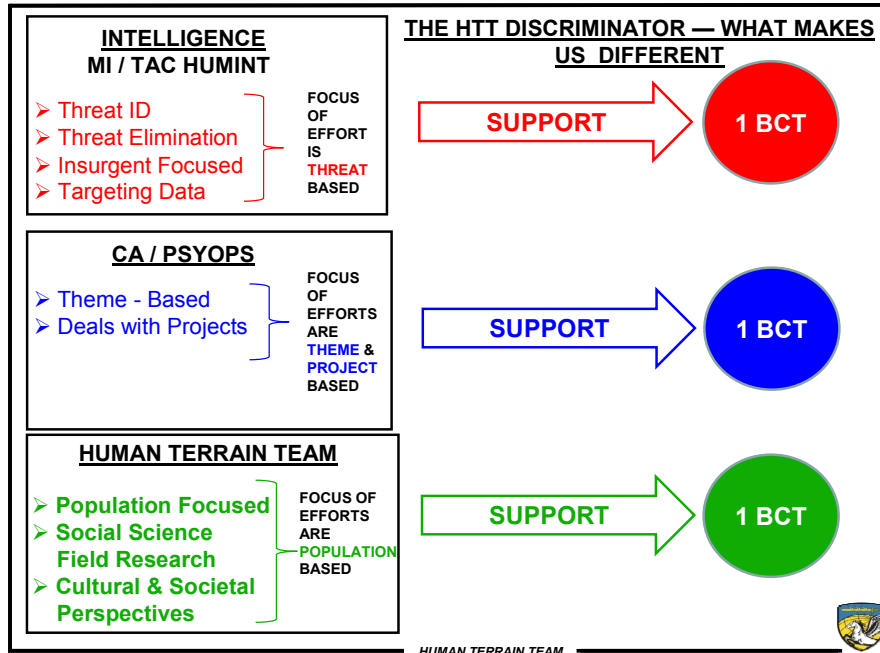

HUMAN TERRAIN TEAM



HTT AREAS OF FOCUS

- Augment planning, decision making, and assessment by providing general understanding and analysis of the local human terrain.
- Sources of Economic Hardship
- Public/Private Potential to Provide Relief
- Role of Historic Conflicts in Current Societal Divisions
- Identify Informal and Formal Leaders
- Identify Most Urgent Needs of Population
- Enhance the BCT's Common Operational Picture





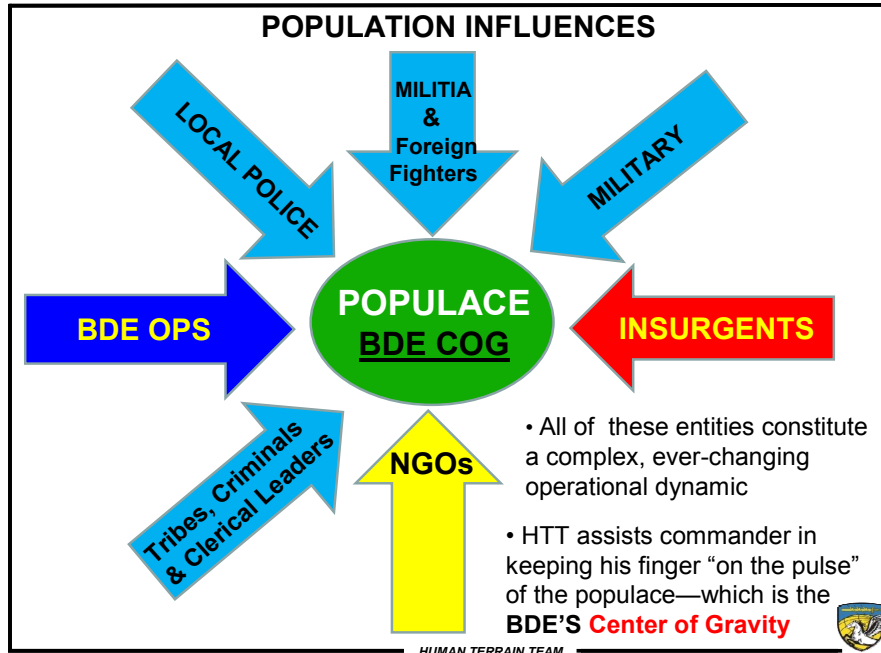

HTT – BCT INTEGRATION

The Human Terrain team is an attached, regionally focused, **special staff element**.

Like other special staff sections—such as the JAG, Chaplain, and Surgeon—the HTT brings to the staff a unique capability in support of the BDE.

HTT is the continuity—BCTs deploy and redeploy, but the team remains in place, ready to support the incoming BCT.

HUMAN TERRAIN TEAM

HTT – BCT INTEGRATION (cont'd)

The HTT will integrate with the BDE and Indigenous Population Through a Three-Phased Process:

- ❑ **Phase I:** Integration and Assimilation
 - Identity building: The “who and the what” of HTT
 - Team Building: HTT interaction with BDE staff — enhance and understand the BDE’s mission and network
 - Understand BDE’s geographic and cognitive terrain
- ❑ **Phase II:** Planning Protocol for Ethnographic Data Collection & Analysis for a Military Operation
 - *Become an active participant in the BDE’s planning cycle and staff battle rhythm*
 - *Define and refine HTT’s research objectives & SOPs*
- ❑ **Phase III:** Fieldwork
 - *Ethnographic interviews*
 - *Employ team-based approach*
 - *Establish methodological approach*
 - *Research analysis and ID of trends and patterns*
 - *Reachback Research Cell*

HUMAN TERRAIN TEAM



HTT INFORMATION COLLECTION SEQUENCE

1. Direct and passive observation
2. Identification and questioning of key informants
3. Snow-balling from key informants
4. Questioning 2nd & 3rd tier informants
5. Triangulation, Compilation, and Analysis



HUMAN TERRAIN TEAM



HTT RESEARCH METHODOLOGY (RM)

HTT Research Design

- Derive mission profile from PIR and CCIR
- Identify themes inherent in PIR and CCIR
- Build questions and interview protocols
- Identify key communicators



HTT Research Methods

- Semi-structured and open-ended interviews
- Recording devices & note taking distract
- Surveys/structured interviews (survey fatigue)
- Participant/Non-participant observation
- Textual analysis (RRC)
- Visual Anthropology (visual clues)

**THE HTT RM ASSISTS THE CDR
IN VIEWING HIS OPERATIONAL
ENVIRONMENT THROUGH
"LOCAL EYES"**

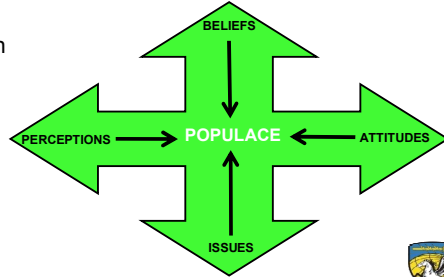

HUMAN TERRAIN TEAM

VILLAGE ASSESSMENTS

Rapid Ethnographic Assessment Protocol in support of BDE ops

Local perspectives provide a measure of priority

- "we need a walkway..."
- "we don't have anything that uses electricity..."
- What they don't know they need

Eliciting tribal info; organization, leadership, power, problems

Identify social networks that affect the local economy

Street shura, focus groups, open-ended interviews, MEDCAPs



Key contribution of HTT is understanding of local human dynamics



HUMAN TERRAIN TEAM

LOGISTICAL REQUIREMENTS

The HTT is entirely dependent upon the BCT for all of the following:

- Billeting
- Transportation
- Rations
- Security
- NIPR/SIPR Connectivity
- Working Space

HUMAN TERRAIN TEAM



Questions?

HUMAN TERRAIN TEAM



IZ 9 Capabilities Brief, 24 July 2008

Appendix C

Sample Research Plan

Research Plan: STRIKE HTT

Project Lead: Dr. Omar Al-Talib in collaboration with Dr. Griffin (Team II)

Work Plan Design by: 1LT Abeita & MSG Howard

Team Lead: Mr. Jonas Reventas

Research Focus: Internally Displaced Persons (IDP)

Research Statement: When reconciliation breaks down – IDPs result. How do we involve IDPs in the reconciliation process and relieve social pressures exerted by IDPs and social pressures exerted on the IDPs by others? Is it sectarian violence that is causing increased tensions in the AO or is the increased pressure of overcrowding stretching limited essential services far beyond their capacity?

Question: What issues are affecting IDPs and what issues are being caused by IDPs?

Data needs:

- Surveys: Both direct and indirect, via interviews or questionnaires, oral histories of post 2003 experience that addresses concerns about basic needs and living condition such as demographics, food purchases, diaries, and perceptions of violence and crime. As much information as we can obtain on the plight of IDPs in the Operational Environment (OE).
- Background data for comparison: US
 - United States Department of Agriculture (USDA) measurement of poverty for cross-national analysis
Statement: Sunni vs. Shia may be a surface issue, the real issue may be ecological

- Comparison populations (i.e. Victims of the tsunami in Asia, victims of Hurricane Katrina in the U.S.)
 - Relocation plans
 - Anti-IDP attitudes
 - Essential Service Needs (sewage, water, electricity, trash removal)
- Surveys: Means of ascertaining population size and location.
 - Use of UAV for aerial survey –
 - Settlement areas
 - Impact of IDPs on local environment
 - Iraqi Ministry of Displaced Persons & Migration
 - U.S. Army Patrol Reports
 - Iraqi Ministry of Planning
 - Iraqi Ministry of Interior
- Info About IDPs – From District Area Councils (DAC)/Neighborhood Area Councils (NAC), community leaders, government officials, then local population, NGOs, BBA's, and Interpreters. Iraqi Army Civil Affair units
 - Problem that may be an issue with data collected from DAC/NACs is a bias that exists with local government leaders referring to IDPs as “Squatters”, they may either overestimate numbers to increase the burden they place on the local government or underestimate them in an effort to marginalize them from being including into society.
- Info From IDPs – Life stories, Interviews, personal narratives, and social network analyses (How did they get into this situation? What is their current situation? How do they plan on changing their situation? Who are their informal leaders alleviating the effects of social dislocation?) Some examples of areas that the team can begin to focus on are:
 - Hygiene and health care issues (quality of life) – What is important to IDPs health wise? (eg. How do they contribute to the problem of tapping into water pipes, which leads to sewage contaminating the water lines? This in turn can lead to health problems.)

- Link into Crime/Violence (quality of life) – What is the crime index compared to a city of the same size and same SES, when the comparable index is removed from equation what level of violence in the city due to the insurgency?
- Link to Reconciliation – Is the increase of violence because of sectarianism or is it because of instability due to economic pressures and IDPs? Who are the key players for reconciliation among the IDP's? Also, is there any link to Shia leaders in the AO that we can utilize as an entry point into the local political environment?

Resources:

- Dr. Al-Talib (Social Scientist): Team lead on research plan, design and implementation
 - Interview Iraqi officials, citizens, Dips, NGOs
 - Attend meetings with Government leaders (DAC/NAC) track needs and ID gaps where cultural intervention may be needed
 - Help facilitate cooperation between CF and Iraqi Forces during meetings/conferences
 - Provide guidance to CF who are seeking to engage Iraqi Forces, Local Nationals and NGOS on reconciliation
 - Analyze acquired data for social science insight, provide guidance to team members during product development
 - Quality control of final products for social analysis and provides final comments to product
- MSG Richard Howard (Cultural Analyst): Interacts with key personalities both inside and outside the brigade
 - Updates database with key officials, stakeholders, dynamic personalities that can analyzed for linkages we can use to maximize effort. (i.e. personal/professional/social connections amongst players). *Does one group have a solution that can be used to help another group or can*

equipment/personnel be shared amongst Muhallas, Hays or districts?

- Lead Person working on Link to quality of life/stability in the Area of Operations. Use of comparative data for violence estimates; *what is the true level of violence in the AO? What cultural, social issues are playing into the cycle of violence? Once ID'd, what cultural or social intervention can be utilized to minimize violence and promote reconciliation?*
- Lead person on working with Brigade Provincial Reconstruction Teams and US Governmental Agencies who are meeting with Iraqi Governmental elements to facilitate funding and planning assistance. *How is the local government and central government including IDP issues in their master plan for reconstruction?*
- Designs and submits “Requests for Information” to fill in data and research gaps needed for research plan. MSG Howard is the primary person responsible for designing, submitting, tracking and answering questions with the Reach back Center. *What type of information can we get ourselves, what do we need help with, who are the lead agencies dealing with IDPs in Iraq?*
- Maintains HTT Toolkit as key person responsible for maintaining the system and updating internal databases.
- Lead person for interacting with engaged units, identifies units trends, beliefs and recommends intervention strategies to the Social Scientist and Team Leader. *What do the soldiers know about local issues? What do they see occurring in the AO?*
- Lead IT person: Identify what new systems, agencies or technology is available and how we can get access to it. *For example, MSG Howard has been thinking if using flyovers to look for locations of IDP settlements and estimating population size by looking at settlement size, trash piles, power hook-ups etc.*
- Lead Team Member for submitting, revising and collecting RFI's to the RRC

- 1LT Steve Abeita (Research Manager) Coordinates team activities, develops ideas for areas of study. Works with social scientist to develop research designs, intervention strategies. Works with Team leader on recommendations for action to Brigade or Governmental Agencies :
 - Take DR. Griffins and DR Al-Talib's conceptualized research design and turn it into specific action plan.
 - Condense/sift data. Take RFI's are verify information by reviewing primary source material used by Research Cell. *Is this information relevant for what we are trying to do, is this information correct, what was left out of the brief?*
 - Expand cursory RFIs into either expanded reports for team database or into short informative briefs for use by Brigade
- Research primary sources from RFIs for data related to other projects, create reports, ppts briefs or excel documents for submittal through portal
- Creation of information database in portal for use by oncoming teams: links, reports, maps, contacts
 - GIS lead for ARCMAP use in creating social map. *What Social/Cultural trends are occurring in the AO? How can these trends, demographics be best presented so that it presents a visual map useful for identifying intervention areas?*
 - Lead on developing informative briefs and/or rapid cultural interventions with Dr. Al-Talib. For Example: Working with local interpreters on culturally inappropriate language use by engaged units.
 - Team co-lead with Dr Al-Talib in working with grass roots groups in AO, for example the Karradah Citizen's Action Group (KCAG). The KCAG is a group of disenfranchised locals who are working on solving community issues such as education, health care and essential services in their community without going through their NAC or DAC leaders.
 - Provides Bi-weekly status reports (WSR) to Brigade Effects Cell on team plans, objectives and on-going projects. WSRs are reviewed by team for accuracy before submittal.
 - Public Health/Medical lead in tracking healthcare issues in the AO. What health care issues are affecting

the AO? How do IDPs fit into the health care model in the AO? What other factors are playing into the status of health care in the AO?

- Essential Services (Water, Power, Sewage, Food)
 - Economic Development (Are IDPs being included)
 - Reconciliation (What is being done to include IDPs in process)
 - Housing (Displaced vs. Squatters, winter is coming)
 - Agriculture: IDPs after being kicked out of their homes and neighborhoods settled in open areas. These open areas are old farms that are being reclaimed by owners.
 - Health Care: 400 Health Care providers (HCP) have been killed/Assassinated in the Brigade AO since 2004. Medical Treatment Facilities (MTF) are built but are left unmanned because of the shortage. Where do IDP's go for care
 - Census: No official census has been taken in Iraq in 25 years, population estimates vary, e.g. (9 Nissan has either 600,000 people or 1.5 Million depending on if you are asking the Central Government or local council. How do you plan for Essential Services without an accurate count?
-
- Mr. Jonas Reventas (Team Leader): Responsible for integrating Team into the Brigade Area of Operations
 - Responsible for security of team members both on and off the FOB
 - Responsible security of information collected and ensuring it is used for cultural/social understanding by the Brigade and not for targeting
 - Responsible for maintaining confidentiality of sources
 - Interacts with senior leadership to identify the Brigades needs and knowledge gaps in the AO.
 - Interacts with team members to identify equipments needs, source identification, facilitate meetings/excursions, coordinate travel and security for missions
 - Briefs senior leadership on team products and intervention strategies.
 - Identifies/Engages potential sources of information (NGOs, Govt Agencies, Coalition Units, Key Personalities)

- Collects and sifts relevant data from sources within the Brigade
- Briefs Readiness Reach back Center (RRC) on team objectives and status.
- Determines priority of product development and distribution method
- Works with other teams to harness group objectives

Steps:

- Team Collaboration/Planning
- Collection of Qualitative data (Very Susceptible to bias)
- Collection of Quantitative data (Very limited on IDPs)
- Resource consolidation
- Assessment
- Gap Identification/Needs collection
- Analysis
- Recommendation: Intervention strategies, policy recommendations etc

Outcomes:

Documented data about IDPs which can be analyzed and lead to recommendations

Timeframe: TBD

- Team collaboration
- Data collection
- Data Analysis
- Reporting/Briefing

IDP link to Area Operation paradigm (Link to public health/Agricultural development/Reconciliation/IDP)

Problem: During Agriculture meeting NAC members it was pointed out that agricultural projects cannot begin in 9-Nissan because Squatters are living on fields needed for crops. Current plan by NAC is to forcibly relocate these people as soon as possible to plant crops before December 1. This will lead to further trauma for already displaced persons that could lead to increased violence and hatred for

government officials, which, could also led to an engagement opportunity for insurgent groups for recruitment. This in-turn will increase Anti-IDP attitudes.

Questions: Where/How is the NAC going to relocate these people?
How many IDPs reside in the area?

Possible recommendations that could result from data:

- Encourage the farmers to hire labor from IDPs (Produce crops as opposed to fodder are labor intensive crops, requiring lots of field hands)
- Encouragement could be linked to Coalition disbursements of aid (i.e. if you want this you have to hire X amount of IDPs as day laborers)
- Secondary Benefits: Traditional produce is high in nutritional vitamins and essential minerals. This will promote increased health care among IDPs leading to:
 - Increased childhood well-being
 - Decreased maternal issues (i.e. birth defects)
 - Increase cognitive development for future generations
 - Healthy workforce
 - Increased income for essential services

Social Theory and IDPs (DR Griffin and DR Al-Talib)

Statement: Sunni vs. Shia may be a surface issue; the real issue may be ecological

1. Structural Functionalism
2. Conflict/Social Marxism (Humanistic)
3. Symbolic Interactionism

Functionalism – Religion trumps skills or education

- Poor IDPs serve as a negative model for socialization
- Best jobs go to most qualified (meritocracy)
- The removal of oppositional sects served to alleviate religious tension/social conflict in society generally

Ecological Perspective

- Not a religious issue but one linked to overpopulation – remove some targeted groups to bring society back under carrying capacity of city infrastructure
- The destruction of social services reduces carrying capacity – must be much lower than population density (compare to other places in the world)

Environment:

- Riparian flood zone – housing may be limited by environmental restrictions of the area

Conflict Theory:

- Society is composed of classes which have competing interests – which leads to conflict
- Capitalism is a cancerous development in human history because it destroys social groups by protecting the interests of individuals and leads to a cultural of commodity consumption that pollutes the environment
- The historical subjugation of Shia by Sunni Institutions developed by the British to control the population
- The new Shia elite are consolidating their power and wealth. Displacing and marginalizing Sunni are functions of maintaining access to the means of power and wealth (i.e., education, leadership roles in military and GoI).

Appendix D

Sample Interview Questions

Example Semi-Structured Interview

Government Official Semi-Structured Questionnaire

**Human Terrain Team, 4th Brigade Combat Team, 82nd Airborne Division
24 February 2008**

Research Program: The objective of this research program is to examine the inter-relationship between: official's backgrounds; their affiliations and relationships (their current and previous ties); and their values (views of future action). Critical questions include: Are affiliation networks intermingled or distinct? Do individuals cooperate and communicate with those with different backgrounds? Some tentative hypotheses include:

Historic affiliation determines current political position
DSGs come from more similar rather than dissimilar backgrounds
DSG ties constitute a distinct/separate social network, separate from other networks

Visual Assessment: Assess who spends time together; Observe formal seating versus informal interactions.

Prior to beginning interview determine whether official has completed the questionnaire.

Personal Background:

How old are you?
Where were you born?
Where were you raised?
What is your qawm and khel?

Where and when did you finish your school?
What groups have you previously belonged to (NGOs, universities, newspapers, tanzims)?
Are you a meshar or mawlawi?

What is your father's profession?
What are your brothers' professions?
Do you have relatives who work in government, police or military?
If you have family members in the government, how can you help each other for solving problems?
What did you do during previous governments?
Please list any previous government positions (years held, district, province):

Government Background:

What is your position?

How long have you been in this position?
What are the responsibilities of your position?
How did you decide to become a [insert position]?
How were you selected for a government position?
Who first recommended you for a government position?
Can you support your family by doing this job?

Network and Affiliation Mapping:

What 5 people here have you known the longest?
What 5 people here were you most recently in contact?
Who are the most important people here?
Who are the most important people in Logar?
What other provincial officials do you work with?
What DSGs do you know the best? How long have you known them?
We heard that one can only become the DC if he knows some government official.
Is that true?
We heard that one of Logar's DC is the most powerful. Can you tell us who he is?

Views on DSGs/District Commissioners:

What is the job of a sub-governor?
What qualities should a sub-governor or district commissioner have?
What are DC's responsibilities to the Provincial Governor?
What is the DC's responsibility to the people?
What kind of Government officials do the people want? Do they want religious people, educated people, or Mujahid?
Who should get the higher positions, in your opinion?
Why do people want to get higher positions?
Currently, what kind of people can easily get high government positions?

Views on Afghanistan:

What needs to be done in Afghanistan?
How does the current government compare to previous governments?
What is a good government?
How should government be run?

Produced by Tom Garcia and Michael Bhatia, Version 2, Aug 2008 ©

Example Tribal Research Questions

I am interested in learning about the tribes. I would like to learn about your tribe and which tribes are above and below your tribe.

1. What is your Ethnicity?
 - a. Pashtun?
 - b. Tajik?
 - c. Other?
2. What is your tribe?
3. Which tribes are under your tribe?
4. Which tribes are above your tribe?
5. Would you write the information for me in Pashto?
6. What is the history of your tribe?
 - a. How long has your tribe been in this area?
 - b. Are there any disputes with other tribes?
 - c. Which tribes are your allies?
 - d. What other villages do people of your tribe live?
7. In which other villages do people in your village have family?
8. What is your first language?
9. Why is that your first language?
 - a. Is that the language of your mother?
 - b. Is that the language of your Father?
 - c. Is that the language of your village?

Appendix E

Example Report Formats

Sample Format Discussion/Point Paper	
Office Symbol (MARKS Number)	(Date)
MEMORANDUM FOR:	
SUBJECT: Format of the Discussion Paper	
1. Issue. How to prepare information and discussion papers.	
2. Facts.	
a. Use of phrases.	
(1) Make significant points clear.	
(2) Avoid complex paragraphs.	
b. Ensure facts flow logically.	
c. Tailor paper for user.	
(1) Determine user's background needs.	
(2) Avoid technical language and unexplained	
acronyms.	
(3) If paper includes sensitive material, identify	
material not to be discussed.	
d. Length is ideally one, but no more than two pages.	
e. Avoid enclosures.	
f. Paper must be authenticated/approved for release.	
3. Key points to be stressed. (Present key points drawn from	
paragraph 2.)	
(Signature Block)	

Sample Format
Position Paper

Office Symbol (MARKS Number) (Date)

MEMORANDUM FOR:

SUBJECT: Format of the Position Paper

1. The position paper is written to “take a stand” on an issue. It is used to evaluate proposals, raise new ideas for consideration, or attack a current situation or proposal.
2. A good position paper has three elements: a brief introduction that states the problem/issue; the basic discussion of facts and considerations; and a conclusion/ recommendation and/or restatement of the position. The introductory paragraph should contain a clear statement of purpose in presenting the issue, and the position on that issue. The bulk of the paper should consist of integrated paragraphs or statements that logically support or defend the position. The discussion systematically leads the reader to the conclusion/recommendations(s).
3. The specific format of the position paper varies. A popular format consists of double spaced, numbered paragraphs of any length – preferably three to eight pages in length. If classified, insure the paper complies with appropriate security regulations governing proper marking, handling, and control procedures.
4. The key to an effective position paper is to get to the point quickly, cover all aspects of the issue in sufficient detail to meet your objective, and close the paper with the feeling that the position is “the” position on the subject.

(Signature Block)

Sample Format

Read Ahead

Office Symbol (MARKS Number) (Date)

MEMORANDUM FOR

SUBJECT: Read Ahead for Date/Time Meeting (or briefing) with (enter name/element)

1. PURPOSE. Purpose should be to provide a succinct statement as to why the Read Ahead is needed. Try to limit to one sentence. For example, "To address issues in developing and implementing procedures for split-team operations.
2. KEY PLAYERS. Provide list of attendees and include those who are unable to attend, but would influence the action if present. If more than five key players, enclose a list of names.
3. PLACE AND TIME: For example, "The briefing room, Building ##, 1400-15--, 30 Aug 27.
4. MAJOR POINTS.
 - a. Provide major points to be made. If the Read Ahead is for a briefing, provide major points, facts, positions, or issues to be briefed.
 - (1) State each point in a brief sentence.
 - (a) Supporting statement 1.
 - (b) Supporting statement 2.
 - (2) Add tabbed enclosures when supporting statements require validation by additional information.
 - b. Major points or views of others (if for a meeting) or issues of others expressing an alternative view.
 - (1) State concurrence or nonconcurrence as in paragraph 4a, above.
 - (2) If views of others are not known, state so.
5. POINT OF CONTACT: Provide POC, office symbol, and telephone number.

(Signature Block)

Appendix F

Commander Feedback

Email from 2nd BCT, 25th ID Commander - August 19, 2008

By way of introduction, I command 2nd Stryker Brigade, 25th Infantry Division, stationed at Schofield Barracks, Hawaii, and currently operating out of Camp Taji, Iraq. We've been in Iraq nearly 9 months (of a projected 15 month tour). Our brigade operates across approximately 1700 sq miles of mostly rural terrain west and north of Baghdad as part of Multinational Division- Baghdad. Our area of operation is distributed across both Sunni and Shia sects and is strongly tribal in tradition and influence. We work over four governmental Qadas (roughly analogous to a US county governmental entity) and partner with four Iraqi Army Brigades and several thousand Iraqi Police. On a personal note, this is my second tour in Iraq, having served here in 2004-2005 as a Stryker infantry battalion commander in Mosul.

We've been supported by a Human Terrain Team since our arrival last December. In summary, the team has become an indispensable asset in helping me understand the complexities of tribal and political relationships and assess the potential results of a variety of lethal and non-lethal actions. Our employment of the HTT has progressed and modified as we've grown as a unit and gained an improved understanding of the complexities of the environment. Initially, the HTT provided us a basic cultural overview of tribal and familial relationships so important in an Arab society. This level of contribution was appropriate to our entry level of knowledge and experience. Over time their contribution has extended to detailed assessment of tribal, political, and cultural interactions that have allowed us to be much more precise in our operational approaches and objectives. The relationships the HTT has established with an extensive network of local tribal personalities has been indispensable to our engagement strategy. I have relied on the HTT to 'penetrate' the cultural gap between Coalition elements and sensitive issues to better facilitate our accomplishing our objectives.

As the HTT program matures I believe we'll see even better interaction with BCTs and a larger return on the Army's investment

into the program. As an Army we have developed a deeper understanding of the importance of cultural awareness and its impact on military operations. I would welcome a further development of the HTT to provide more habitual support to the brigade through pre-deployment training and operations. We are quickly improving our integration of the HTT into our broader staff processes and exploring its doctrinal role in the staff structure.

In summary, the Human Terrain Team is an integral and critical element that I rely on daily as part of my engagement and assessment strategy in executing counterinsurgency operations. In an environment characterized by human terrain, the HTT provides me dedicated, educated, and responsive information and assessments that allow this brigade to accomplish its objectives. I welcome their input and look forward to further development, resourcing, and integration of the capability.

Please contact me if you have any other questions.

v/r

Todd B. McCaffrey
COL, IN
Commanding
Stryker Brigade Combat Team- Warrior
2nd Brigade, 25th Infantry Division
Tropic Lightning!