

---

---

# **FM 100-30**

# **NUCLEAR OPERATIONS**

**Headquarters, Department of the Army**

---

---

**DISTRIBUTION RESTRICTION:** Distribution authorized to U.S. Government agencies only to protect technical or operational information from automatic dissemination under the International Exchange Program or by other means. This determination was made on 1 June 1993. Send requests to Commandant, U.S. Army Combined Arms Center and Fort Leavenworth, ATTN: ATZL-GCJ-S, Fort Leavenworth, KS 66027-5050.

**DESTRUCTION NOTICE:** Destroy by any method that will prevent disclosure of contents or reconstruction of the document.

# NUCLEAR OPERATIONS

## CONTENTS

	PAGE
<b>PREFACE</b> .....	vi
<b>Chapter 1 TRANSITION FROM JOINT NUCLEAR DOCTRINE</b> .....	1-1
THE NUCLEAR ENVIRONMENT .....	1-1
LEVELS OF WAR .....	1-1
DETERRENCE .....	1-2
THE THREAT .....	1-2
PROLIFERATION, NONPROLIFERATION, AND COUNTERPROLIFERATION ...	1-3
NUCLEAR FORCES .....	1-4
LEADERSHIP .....	1-4
TRAINING .....	1-4
SUMMARY .....	1-5
<b>Chapter 2 EMPLOYMENT CONSIDERATIONS</b> .....	2-1
WEAPONS EFFECTS AND THE COMBAT ENVIRONMENT .....	2-1
Blast .....	2-1
Thermal Radiation .....	2-1
Residual Ionizing Radiation, Initial Radiation, and the Operational Exposure Guide (OEG) .....	2-2
Electromagnetic Pulse (EMP) .....	2-3
UNIT SURVIVABILITY .....	2-4
Positioning (Dispersion) .....	2-5
Mass Versus Dispersion .....	2-5
Countermeasures .....	2-5

---

**DISTRIBUTION RESTRICTION:** Distribution authorized to U.S. Government agencies only to protect technical or operational information from automatic dissemination under the International Exchange Program or by other means. This determination was made on 1 June 1993. Send requests to Commandant, US Army Combined Arms Center and Fort Leavenworth, ATTN: ATZL-GCJ-S, Fort Leavenworth, KS 66027-5050.

**DESTRUCTION NOTICE:** Destroy by any method that will prevent disclosure of contents or reconstruction of the document.

	Mitigation Techniques . . . . .	2-6
	EQUIPMENT SURVIVABILITY . . . . .	2-6
	Methods and Techniques to Enhance Survivability . . . . .	2-6
	Nuclear Environment Arrival Times . . . . .	2-7
	DYNAMICS OF COMBAT POWER . . . . .	2-7
	SUMMARY . . . . .	2-7
<b>Chapter 3</b>	<b>PLANNING NUCLEAR OPERATIONS . . . . .</b>	<b>3-1</b>
	JOINT NUCLEAR OPERATIONS . . . . .	3-1
	The Deliberate-Planning Process . . . . .	3-2
	Planning Guidance . . . . .	3-2
	Targeting . . . . .	3-3
	The Crisis-Action Planning Process . . . . .	3-3
	Force Projection . . . . .	3-3
	The Stages of Force Projection . . . . .	3-3
	Entry Operations . . . . .	3-3
	THE CORPS AS A JOINT TASK FORCE . . . . .	3-5
	JOINT NUCLEAR-WEAPONS EMPLOYMENT SUPPORT . . . . .	3-5
	The Planning and Execution Cycle . . . . .	3-5
	Coordination . . . . .	3-8
	Contingency Operations . . . . .	3-10
	MULTINATIONAL OPERATIONS . . . . .	3-11
	PLANNING JOINT NUCLEAR OPERATIONS . . . . .	3-12
	Command Guidance . . . . .	3-12
	The Operational Level of War . . . . .	3-13
	Airspace Coordination . . . . .	3-13
	Nuclear Targeting . . . . .	3-13
	Identifying Enemy Targets . . . . .	3-13
	Targeting Considerations . . . . .	3-14
	Troop Safety . . . . .	3-14
	Decide, Detect, Deliver, and Assess (D <sup>3</sup> A) Targeting Methodology . . . . .	3-15
	Defeat Criteria . . . . .	3-15
	Collateral-Damage Prevention . . . . .	3-16
	Options . . . . .	3-16
	BATTLEFIELD OPERATING SYSTEMS (BOS) . . . . .	3-17

	Intelligence . . . . .	3-17
	Maneuver . . . . .	3-17
	Fire Support . . . . .	3-18
	Mobility and Survivability . . . . .	3-18
	Combat Service Support (CSS) . . . . .	3-18
	Command and Control . . . . .	3-18
	Air Defense . . . . .	3-18
	RECONSTITUTION . . . . .	3-19
	SUMMARY . . . . .	3-19
<b>Chapter 4</b>	<b>COMMAND AND STAFF RESPONSIBILITIES AND PROCEDURES . . . . .</b>	<b>4-1</b>
	RESPONSIBILITIES . . . . .	4-1
	THE DECISION-MAKING PROCESS . . . . .	4-1
	Mission Analysis . . . . .	4-1
	Commander's Guidance . . . . .	4-2
	Course of Action Development . . . . .	4-2
	Course of Action Analysis . . . . .	4-4
	THE COMMANDER'S DECISION . . . . .	4-5
	PROCEDURES . . . . .	4-7
	Plans (Orders) Preparation . . . . .	4-7
	Approval and Issuance of the OPLAN (OPORD) . . . . .	4-7
	SUPERVISION . . . . .	4-8
	MISSION ACCOMPLISHMENT AND FEEDBACK . . . . .	4-9
	SUMMARY . . . . .	4-9
<b>Chapter 5</b>	<b>NUCLEAR SUPPORT TO COMBAT OPERATIONS . . . . .</b>	<b>5-1</b>
	TENETS OF ARMY OPERATIONS . . . . .	5-1
	AREA OF OPERATIONS (AO) . . . . .	5-1
	CHARACTERISTICS OF OFFENSIVE OPERATIONS . . . . .	5-2
	Forms of Tactical Offense . . . . .	5-2
	Forms of Maneuver . . . . .	5-3
	PLANNING THE OFFENSE . . . . .	5-3
	Mission . . . . .	5-3
	Enemy . . . . .	5-4
	Troops . . . . .	5-4
	Terrain and Weather . . . . .	5-4



	Time Available .....	5-4
	CONDUCTING OFFENSIVE OPERATIONS .....	5-4
	CHARACTERISTICS OF DEFENSIVE OPERATIONS .....	5-5
	Mobile Defense .....	5-5
	Area Defense .....	5-6
	PLANNING THE DEFENSE .....	5-7
	Mission .....	5-7
	Enemy .....	5-7
	Troops .....	5-7
	Terrain and Weather .....	5-7
	Time Available .....	5-8
	CONDUCTING DEFENSIVE OPERATIONS .....	5-8
	Deep Operations .....	5-8
	Close Operations .....	5-8
	Rear Operations .....	5-9
	Reserve Operations .....	5-9
	SUMMARY .....	5-9
<b>Chapter 6</b>	<b>COMBAT SERVICE SUPPORT IN A NUCLEAR ENVIRONMENT .....</b>	<b>6-1</b>
	THE COMBAT SERVICE SUPPORT PROCESS .....	6-1
	COMBAT SERVICE SUPPORT OPERATIONS .....	6-1
	Anticipation .....	6-1
	Integration .....	6-1
	Continuity .....	6-2
	Responsiveness .....	6-2
	Improvisation .....	6-2
	COMBAT SERVICE SUPPORT FUNCTIONS .....	6-2
	Personnel Support .....	6-2
	Maintenance .....	6-3
	Transportation .....	6-4
	Combat Health Support (CHS) .....	6-4
	Field Services .....	6-5
	Supply .....	6-6
	SUMMARY .....	6-8
	<b>GLOSSARY .....</b>	<b>Glossary-1</b>

ACRONYMS AND ABBREVIATIONS .....	Glossary-1
Acronyms .....	Glossary -1
Definitions .....	Glossary-3
<b>REFERENCES</b> .....	References-1
<b>INDEX</b> .....	Index-1

## PREFACE

In the past, Soviet-styled armored echeloned formations were the primary threat to the United States (US). In response to this threat the US designed and stockpiled tactical nuclear weapons. Today's threats consist of regional instabilities and the proliferation of weapons of mass destruction (WMD). However, the US, as well as many other nations, actively pursues a policy of nonproliferation. Despite this, the number of nations who have, or are developing, nuclear weapons continues to grow. Therefore, the US may some day find itself confronted by an opponent who possesses nuclear weapons. Because of the continuing reduction in the size of US military forces, the US could also find itself opposed by an overwhelming conventional threat. Either scenario could lead to the use of nuclear weapons. Therefore, the US must concern itself with countering the proliferation of weapons of mass destruction.

Despite the continuing drawdown of US military forces, the current national military strategy includes fighting and winning two near-simultaneous regional wars with conventional forces. Any US threat of employing nuclear weapons is to deter a potential adversary's use of such weapons. If deterrence fails, the goal is to end hostilities on terms acceptable, at the lowest level of conflict, to the US and its allies. However, the US unilaterally reserves the right to use nuclear weapons if necessary. Use would be restricted, of course, with tight limits on the area and time of use. This would allow the belligerent to recognize the "signal" of limited response and to react accordingly.

The Army describes battlefield nuclear warfare (BNW) in terms of being able to conduct continuous combat operations in a nuclear environment. The presence of any nuclear-capable system, before, during, or after nuclear-weapons employment by either friendly or enemy forces, creates a nuclear environment. The implications of their very presence creates the nuclear environment.

Before 1991, the US Army had custody of tactical nuclear weapons which were to be employed, on Presidential release, by organic Army field artillery units. In September 1991, the Presidential Nuclear Initiative (PNI) removed the organic nuclear responsibility from the US Army. Today the Army neither has custody of nuclear weapons nor do corps and divisions employ them. The US Air Force or the US Navy are now responsible for delivery of nuclear weapons in support of Army operations. The Army retains its role in nominating nuclear targets and is also responsible for nuclear force protection.

This manual establishes Army doctrine for operations in a nuclear environment and details the doctrine for integrating nuclear considerations into all other aspects of the battlefield. It also describes the Army's role in nominating targets at corps and above levels and protecting the force from the effects of nuclear weapons detonation.

Nuclear operations may occur at strategic, operational, and tactical levels of war. Nuclear employment in a theater of operations has theater strategic, operational, and tactical results; execution has national strategic implications. The corps' role is to function at either the tactical or operational levels of war. At the tactical level, the corps accomplishes missions as Field Manual (FM) 100-15 describes. At the operational level, when directed and augmented, the corps functions as either the Army force (ARFOR), the joint force land component command (JFLCC), or a joint task force (JTF). By viewing the corps in its many possible roles, the reader can also discern nuclear procedures for echelons above corps (EAC) and joint missions.

This manual can help educate and train commanders and staffs at corps and operational levels in nuclear operations and educate and train divisions in nuclear force protection. It is used with Joint Publications (JP) 3-12.1, 3-12.2 (SRD), or 3-12.3, and serves as the bridge between joint and

Army doctrine. It is also used with FM 25-50, which contains training doctrine for nuclear survivability.

The proponent of this publication is headquarters (HQ), US Army Training and Doctrine Command (TRADOC). Submit changes and suggestions, on Department of the Army (DA) Form 2028, to the Commanding General, US Army, Combined Arms Center (CAC), ATTN: ATZL-SWW-L, Fort Leavenworth, KS 66027.

The reader should review the glossary to become familiar with terms and definitions used in this manual.

Masculine pronouns apply to both men and women.

## Chapter 1

# TRANSITION FROM JOINT NUCLEAR DOCTRINE

### THE NUCLEAR ENVIRONMENT

A nuclear environment exists if either adversary in a conflict possesses nuclear capabilities and if any of the following elements are present:

- There is a capability by a belligerent to deliver weapons of mass destruction.
- A nuclear weapon is in the area of responsibility (AOR).
- There is a possibility of deployment or employment of nuclear weapons into an AOR.

In a nuclear environment decisive battles might be greatly compressed. The course of campaigns could be radically altered or accelerated. The threat of, and the lethal consequences of, nuclear-weapons use can greatly influence military operations and increase the battlefield's complexity. The Army, supported by joint assets, must be capable of conducting all operations in such an environment.

Nuclear operations fall into two basic categories: immediate nuclear support and preplanned nuclear support. Both terms define the use of nuclear weapons against hostile forces in support of friendly air, land, and naval operations (nuclear support). Should the employment of nuclear weapons become necessary, the commander in chief (CINC) and/or joint forces commander, after receiving release permission from the President through the National Command Authorities (NCA), can use either of these two forms of support—

- To alter the balance between firepower and maneuver.
- To affect the tempo and destructiveness of operations.
- To respond to the enemy's use of weapons of mass destruction.

Using nuclear weapons at the proper time and place can create conditions for decisive results. Commanders at corps and above integrate nuclear

weapons into other systems to achieve the greatest operational advantage. Nuclear-weapons use will not change warfare fundamentals. However, it will create conditions that could significantly affect how commanders apply them.

### LEVELS OF WAR

The levels of war—strategic, operational, and tactical—help clarify activities by echelons within the theater across the full range of military operations. They provide a useful framework within which a CINC can order activities within his area of responsibility. The levels of war also help commanders visualize a logical flow of operations, an allocation of resources, and the assignment of tasks. Each level of war is defined by the extent of command authority, scope of perspectives, designated responsibilities, and the intended outcome.

At the strategic level of war, the perspectives are worldwide and long-range. At the operational level of war, military forces attain theater strategic objectives through designing, organizing, and conducting campaigns and major operations. The concern at the tactical level of war is the execution of battles and engagements.

The CINC normally operates at the theater strategic level of war. The corps commander could be the senior Army commander subordinate to the CINC. In this capacity he may operate at the operational or tactical levels. In this situation the corps commander may also be responsible for the nuclear target-nomination process and the nuclear, biological, and chemical (NBC) protection process.

Concerns and views regarding nuclear employment differ at each level of nuclear operations. Battlefield nuclear operations support the operational-level commander's concept and intent. Corps and EAC commanders are normally responsible for nuclear target nominations. Commanders at division and lower levels normally operate at the tactical level of war and are responsible for the NBC defense process.

## DETERRENCE

Although the US military force's overriding mission is to deter war, especially nuclear war, the intent behind the 1991 Presidential Nuclear Initiative (PNI) was to enhance national security through arms reduction while preserving the capability to regenerate selected forces if required. Recent arms control agreements and unilateral initiatives provide for real reductions in the arsenals of nuclear powers. However, even with the most optimistic outlook, the sheer number of remaining weapons is formidable. An increasing number of potentially hostile states are developing or have the capability to develop weapons of mass destruction. Therefore, the US must maintain a modern, reliable, and fully capable strategic deterrent as its number one defense priority.

Deterrence is the product of a nation's military capabilities and that nation's willingness to use those capabilities. The US' policy is to terminate conflict at the lowest possible level of violence consistent with national and allied interests. The ability to conduct operational- and tactical-level nuclear activities enhances US deterrent policy.

The potential employment of nuclear weapons at theater level, when combined with the means and resolve to use them, makes the prospects of conflict more dangerous and the outcome more difficult to predict. The US' position is that it can achieve deterrence if any potential enemy believes the outcome of nuclear war to be so uncertain, and the conflict so debilitating, that he will have no incentive to initiate a nuclear attack. The resulting uncertainty reduces a potential aggressor's willingness to risk escalation by initiating conflict.

At the same time, a credible defensive capability, which would include the threat of employing nuclear weapons, could bolster the resolve of allies to resist an adversary's attempts at political coercion. For example, the US' capability of responding to biological and chemical attacks with nuclear weapons would likely reduce or eliminate such attacks.

Nuclear weapons contribute to but do not by themselves ensure deterrence. To have a credible nuclear deterrent requires a nation to have the means, the ability, and the will to employ nuclear weapons. The nation must also have—

- A reliable warning system.

- A modern nuclear force.
- The capability and flexibility to support a spectrum of response options.
- A deployable defensive system for theater protection.

The threat of nuclear escalation is a major concern in any military operation involving the armies of nuclear powers. Controlling escalation is essential to limiting a rational threat's incentive for nuclear response. Escalation control involves a careful selection of options to convey to the enemy that, although the US is capable of escalating operations to a higher level, it has deliberately withheld strikes.

The US views restraint in the use of nuclear weapons as an important way to control the escalation of warfare. Restraint provides leverage for a negotiated termination of military operations. However, the US cannot assume a potential enemy will view restraint in the same way, or that he will not employ weapons of mass destruction. Therefore, the US must be capable of deploying those forces necessary to defeat aggression, provide coercion, and bring the war to a speedy termination on terms favorable to the US and its allies. Commanders and staffs at all levels must continue to be familiar with nuclear-weapons effects, the actions required to minimize such effects, and the risks associated with using nuclear weapons.

## THE THREAT

The Cold War era's definitive threats to American security were nuclear surprise attack and the possible invasion of Western Europe. The new threat is worldwide regional instability (including the possible regional use of nuclear weapons) coupled with the proliferation of weapons of mass destruction.

Developing countries as well as regional powers are gaining the ability to manufacture nuclear arsenals. The current threat from developing nations primarily consists of short- and intermediate-range ballistic and cruise missiles and aircraft capable of carrying nuclear weapons and other weapons of mass destruction. Other threats, such as terrorists groups, may also possess nuclear weapons.

A nation that has the capability of using ballistic or cruise missiles and high-speed aircraft to deliver weapons of mass destruction at extended ranges

significantly increases those weapons' effectiveness as instruments of terror. Such capability also enhances the possibility of conflict escalation beyond a hostile region's boundaries.

The use of, or the threat of using, weapons of mass destruction within a campaign or major operation can cause large-scale shifts in objectives, phases, and courses of action (COA). Nuclear weapons make it possible to drastically change the effective ratio of regional forces and equipment and to create conditions favorable to a threat's operations. Consequently, if a potential adversary is not successful conventionally, he might consider using weapons of mass destruction.

The most accepted enemy employment methodology to destroy critical targets is surprise. A potential enemy might try to destroy massed units and all other critical targets using various nuclear-weapons burst options (space bursts, air bursts, surface bursts, below-surface bursts). Such attacks might be single attacks or part of a group of massed nuclear strikes. Therefore, retaliation or escalation would result in the likelihood of nuclear use against friendly forces. Or, retaliation or escalation could be used in response to an enemy's first use of weapons of mass destruction.

One element of the commander's critical information requirements (CCIR) is determining if the theater threat is capable of using weapons of mass destruction. The answer dictates future command actions.

## **PROLIFERATION, NONPROLIFERATION, AND COUNTERPROLIFERATION**

Proliferation is the process by which one nation after another comes into the possession of or attains the right to determine the employment of nuclear weapons, each potentially able to launch a nuclear attack upon another nation. Nonproliferation efforts focus on preventing the spread of missiles and weapons of mass destruction through arms and export controls beyond the scope of corps and EAC interest. Counterproliferation strategy focuses on military measures centering both on how to deter or discourage as well as how to defend and attack against the possible use of such weapons.

The Department of Defense's (DOD) counterproliferation initiative recognizes the goal of preventing proliferation of weapons of mass destruction and their associated delivery systems. It also recognizes that the US must continue to expand its efforts to protect forces, interests, and allies. The initiative has two fundamental goals:

- To strengthen DOD's contribution to governmentwide efforts to prevent, or diplomatically reverse, the acquisition of weapons of mass destruction.
- To protect US interests and forces (as those of its allies) from WMD effects by assuring that US forces have the equipment, doctrine, and intelligence needed to confront, if necessary, any future opponent who possesses weapons of mass destruction.

The Department of Defense marshals its unique technical, military, and intelligence expertise—

- To improve arms control compliance.
- To control exports.
- To inspect and monitor the movement of nuclear materials.
- To interdict shipments for inspection during crises.
- To strengthen the norms and incentives against WMD acquisition.

The Department of Defense's acquisition strategy in the areas of command, control, communications, and intelligence (C<sup>3</sup>I), counterforce operations, active defense, and passive defense address the following critical counterproliferation challenges:

- Detecting and destroying WMD capabilities from production through storage to deployment.
- Conducting military operations in a WMD environment.
- Dealing with consequences of WMD use, including medical treatment, clean-up, and recovery.
- Coping with the diffusion of new technologies.

NOTE: This manual concerns the nuclear part of weapons of mass destruction.

Although nuclear weapons are an element of deterrence, potential regional adversaries might or might not understand the deterrence value of the

US' nuclear weapons. If the goals of promoting peace, deterring war, and resolving conflicts fail, deterrence fails. Therefore, fighting and terminating hostilities become paramount. United States doctrine assumes that if the potential foe is capable of using weapons of mass destruction, then US forces must act accordingly.

## NUCLEAR FORCES

Nuclear-capable forces (Navy and Air Force) are instruments of national power in regional conflicts. They contribute to theater deterrence or provide a war-fighting option to the NCA.

Because the Army no longer has an organic nuclear capability, the Navy or Air Force will provide nuclear support. The Army can now only nominate nuclear targets, usually at no lower than the corps level. The division normally is limited to NBC protection activities.

The capability of the US to deploy nuclear forces into a theater significantly complicates the enemy's planning process. The alert status of nuclear forces is a function of the world situation at any given time and, thus, enhances their responsiveness.

## LEADERSHIP

Battlefield stress in a nuclear environment will be higher than US forces have ever experienced. Only disciplined, well-trained, and physically fit units can function well in such an environment. Commanders who understand this and who provide soldiers with strong, positive leadership; good mental and physical preparation; and clear, comprehensive plans will ensure soldiers are in a better position to survive and win.

Units may have to operate with reduced mutual support and fire support, with degraded electronic communications abilities along extended lines of communications (LOC), and possibly without centralized control or continuous communications. Therefore, to improve command and control (C<sup>2</sup>) leaders must work toward three general goals (which take on added importance in nuclear operations):

1. Instill an aggressiveness in their units that will transcend the shock and stress of the nuclear environment.

2. Train junior leaders to think and operate independently.
3. Develop small-unit cohesion.

Commanders and staffs must fully understand the potential of nuclear-weapons use by both an adversary and by a US joint force. They must also have a working knowledge of—

- Nuclear-weapons effects.
- Employment doctrine.
- Survivability measures necessary to preserve combat power.
- Medical requirements as a result of a nuclear explosion.
- The psychological impact of nuclear warfare on soldiers and units.

As commanders plan and fight successive battles involving actual or possible nuclear operations, they must continually assess their soldiers' psychological and physiological stresses. Commanders must emphasize situations in training, exercises, and leadership which will help soldiers accomplish their missions.

## TRAINING

On a nuclear battlefield every soldier will confront new and strange circumstances and be under constant danger of attack. Nuclear weapons will quickly cause many casualties as well as intermediate and long-term radiation effects. Soldiers will be exposed to death and destruction of a magnitude far beyond imagination and may have to operate in widely dispersed, isolated, and semi-independent groups. Everyone must understand and practice survival and mitigation techniques. Such techniques will give soldiers direction and confidence in a confusing, frightening situation.

The large and sudden losses that a nuclear attack will cause will shock and confuse inadequately trained or psychologically unprepared troops. Reaction times will be slower, and the ability to respond to leadership and the desire to perform at peak proficiency may be degraded. The violence, stress, and confusion can easily divert attention from battlefield objectives. Extraordinary discipline and leadership are vital to overcoming distractions,



maintaining the mission's focus, and pressing the fight.

Training, the cornerstone of success, technically and psychologically prepares soldiers for the nuclear environment. Successful nuclear operations require expanded combat training that includes—

- Mitigation techniques against nuclear effects.
- Radiation monitoring.
- Decontamination techniques.
- Operations exploiting nuclear-weapons use.
- Recovering and regrouping after an attack.
- Handling mass casualties.
- Having to use degraded resources to accomplish the mission.
- Nominating nuclear targets.

Soldiers will fight as well or as poorly as they have been trained. Clear, concise policies and guidelines provide control and direction. Commanders must emphasize the fact that aggressive maneuver, even by relatively small units, will have a high probability of success in the confused aftermath of a nuclear attack.

NOTE: See FM 25-50 for in-depth discussions of these topics.

## SUMMARY

This chapter describes the transition of joint nuclear doctrine to Army-oriented nuclear doctrine. A nuclear environment exists if either adversary in the conflict possesses nuclear capabilities. The levels of war clarify simultaneous activities Army forces conduct in the theater. Each level supports the next higher level of war.

The overall mission of military forces is to deter war—especially nuclear war. If deterrence fails, the US must be capable of deploying the forces necessary to defeat aggression, provide cohesion, and bring war to a speedy termination on terms favorable to the US and its allies.

The threat is worldwide regional instability (including possible use of nuclear weapons) coupled with the proliferation of weapons of mass destruction. Proliferation occurs when nations acquire and have the ability to use nuclear weapons against another nation. Nonproliferation activities attempt to prevent the spread of weapons of mass destruction. Counterproliferation centers on how to deter, defend, and attack against possible use of nuclear weapons.

In the event of either friendly or enemy nuclear-weapons use, commanders must provide soldiers with strong positive leadership, good mental and physical preparedness, and clear comprehensive plans. Positive leadership will ensure soldiers survive and win. Training is the cornerstone for success.

## Chapter 2

# EMPLOYMENT CONSIDERATIONS

### WEAPONS EFFECTS AND THE COMBAT ENVIRONMENT

Nuclear weapons add significantly to the physical and psychological environment of combat. They cause intense, violent effects which severely affect unit movement, employment, and protection. Commanders at all levels must understand the operational and tactical implications of the nuclear environment and its effect on operations.

The basic effects of a nuclear detonation are blast, thermal radiation, residual ionizing radiation, initial radiation, and electromagnetic pulse (EMP). These effects can destroy or neutralize targets as well as impair, through physical injury, the operational capability of personnel. Flash blindness, radiation sickness, eardrum rupture, and second-degree burns are some of the injuries persons might experience.

Weather, terrain, surface conditions, and man-made structures modify nuclear-weapons effects. Also, conditions existing naturally on the battlefield at any given moment can enhance or mitigate such effects. Therefore, commanders must adequately prepare and train their units for all possibilities.

NOTE: See JP 3-12.2 (SRD) (for US military forces only), JP 3-12.3, and DA Pamphlet (Pam) 50-3 for in-depth discussions of nuclear effects.

#### Blast

The blast wave (static overpressure and dynamic pressure) from a nuclear air burst mostly causes materiel damage. Surface and subsurface bursts generally produce less air-blast damage and more cratering.

Most data on blast effects describe blasts as observed on flat or gently rolling terrain. There is no quick and simple method for calculating changes in blast pressures in hilly, mountainous, or forested terrain. In general, compared to the same distance on flat terrain, pressures are greater on the forward slopes of steep hills and lower on reverse slopes.

Line-of-sight (LOS) shielding is not dependable; blast waves can bend or diffract around obstacles.

Hills may decrease dynamic pressure and offer some local protection from flying debris. However, small hills or folds in the ground are considered negligible for target analysis. Wooded hills lessen dynamic pressure, but do not significantly affect overpressure. Wooded hills will also produce significant wood splintering, tree blowdown, and forest fires.

The reflecting nature of a surface over which a weapon detonates significantly influences the distance to which blast effects extend. Smooth, reflecting surfaces such as ice, snow, sand, moist soil, and water reflect most of the blast energy, maximizing its effects. Conversely, surfaces with thick, low, combustible vegetation; dry soils with sparse vegetation; and desert sand minimize such effects.

Built-up areas do not significantly affect a blast wave's effects. And, even though urban structures may provide some local shielding from flying debris, they can also increase pressures by channeling a blast wave.

Weather conditions also affect blast damage. Rain and fog lessen the force of the blast wave by increasing air density and moisture. These conditions help dissipate the energy of the blast wave as it moves through the heavier air.

#### Thermal Radiation

A fireball's intense heat possesses high thermal energy that, as thermal radiation, is transmitted from the point of detonation over a wide area. Thermal radiation travels at wavelengths from ultraviolet to infrared. The atmosphere absorbs some of the ultraviolet radiation; therefore, the prime source of thermal radiation is the infrared.

Thermal radiation can ignite materiel and cause serious burns. However, the effect of thermal radiation on a target is influenced by many factors, including the state of the atmosphere and the target's thermal absorption qualities (color, thickness, consistency, and reflective properties). For example, when a weapon detonates below an overcast sky, the underside of the cloud layer acts as a reflector.

The reflected energy is then added to that coming directly from the point of explosion.

The differing levels of energy released from the various-yield weapons further complicates the use of thermal effects for targeting. The level of energy released is not the only effect; the rate at which it is released also has impact. Smaller weapons release thermal energy relatively quicker than larger ones. Also, larger weapons generate heat more slowly, taking longer to dissipate or be conducted away. Therefore, the total amount of thermal energy available for a given type of weapon is directly proportional to its yield.

Although not a basic effect, flash blindness is a phenomenon that soldiers might experience from the thermal effect from a nuclear explosion. Flash blindness takes two forms—dazzle and retinal burns.

Dazzle is the most common form of flash blindness. Its effect is similar to the temporary blindness that camera flash bulbs or bright car headlights at night cause. The difference is in intensity. Dazzle effects from a flash bulb are a temporary inconvenience. Effects from a nuclear burst are prolonged and cause far greater loss of vision. Looking directly at a burst causes severe impairment of vision for from 2 to 3 minutes by day to over 10 minutes at night when the pupils are fully dilated. Two minutes is a long time on a battlefield and seems longer to pilots flying high-speed aircraft.

The second and more serious form of flash blindness results from retinal burns received when the lens of the eyes focus the image of the fireball onto the back of the eyes. Estimates of the risk of retinal burns vary. Small pinpoint retinal burns may heal in time, but greater damage is unlikely to do so and will leave a permanent blind spot in the affected eye. Some sources believe that only a small percentage of troops will receive such injuries; others believe this could be a more serious threat.

### **Residual Ionizing Radiation, Initial Radiation, and the Operational Exposure Guide (OEG)**

Residual ionizing radiation typically occurs after the first minute of detonation. It primarily consists of energized impurity particles and debris falling back to earth because of air movement and/or

rainout. Residual ionizing radiation could be a lingering and widespread operational hazard.

Within the first minute after a nuclear-weapon detonates, initial radiation, in the form of x-rays, gamma rays, and neutrons, is emitted. Initial radiation travels at nearly the speed of light and can penetrate and damage materiel and injure personnel. Initial radiation can help defeat the enemy, but it can also endanger friendly forces and the local civilian population.

Denser air at sea level absorbs more initial radiation than thinner air at higher altitudes. As the height of burst (HOB) or the temperature of the air increases, the air density decreases. This allows initial radiation to extend farther because it is less absorbed by air molecules.

An important factor influencing the amount of initial radiation a target receives is shielding. For example, the surrounding ground, acting as an absorber or shield, will sharply reduce the initial radiation from surface and subsurface bursts. Terrain features can greatly influence initial radiation effects. Minor irregularities, such as ditches, gullies, and small folds in the ground, offer some protection. Major terrain features, such as large hills and forests, can provide significant protection for equipment and personnel, depending on the height of burst.

People inside buildings, tanks, or individual fighting positions receive lower initial radiation doses than people in the open and at the same distance from the nuclear detonation. How much less depends on how much initial radiation the intervening material absorbs. All material absorbs some nuclear radiation. However, because of the high penetrating power of neutrons and gamma rays, the shielding material must be quite thick to provide significant protection.

Dense materials such as armored vehicles offer excellent protection against gamma rays. Some readily available low-density materials offer the best protection against neutrons. Depending on its moisture content, soil may also be a good neutron shield. For example, an individual fighting position with 1 meter of overhead soil protection will shield its occupant from as much as 98 percent of the neutron radiation.

Material sufficient to protect against gamma rays also provides some protection against neutrons. As

a general guideline, soldiers can construct shields of minimum thickness meant to absorb both neutrons and gamma rays by either alternating layers of high- to low-density materials or by thoroughly mixing such materials.

Units may encounter nuclear contamination from sources other than weapons detonation. Possible sources include fallout caused by the destruction of an enemy's nuclear weapons production facility, enemy stockpiled weapons, and nuclear energy reactors (both friendly and enemy).

Another source of contamination would be the deliberate spread of radioactive material over friendly forces or terrain. A nuclear environment can be created without the introduction or detonation of a yield-producing weapon. Therefore, commanders at all levels must be aware of this possibility as well as the possibility of the contamination from non-weapons sources that could significantly affect operations.

NOTE: See FM 3-15 and the FM 3-series manuals for a description of actions to counter these events.

The operational exposure guide (OEG), expressed in terms of negligible or emergency risk criteria, is the key to nuclear contamination avoidance. The OEG gives the commander a flexible system of radiation exposure control. The commander specifies OEG for his unit's level of radiation. The level of exposure must be kept as low as possible. Based on the stated OEG, leaders can select units with low radiation exposure to perform necessary missions.

Establishing and using OEG procedures helps leaders successfully employ units on a radiologically contaminated battlefield while keeping exposure to the minimum extent possible consistent with the mission. Ignoring exposure control would be disastrous.

### **Electromagnetic Pulse (EMP)**

On impact with the earth's atmosphere or with solid materials, initial radiation liberates free electrons. The free electrons create two additional effects: the EMP and the transient radiation effects on electronics (TREE). The EMP can severely degrade and destroy unprotected command, control, communications, computers, and intelligence (C<sup>4</sup>I) operations.

Electromagnetic pulse directly injures personnel only if they are physically touching metallic collectors, such as cables, at the time of an EMP surge. Hazards may also exist from indirect or secondary EMP effects. For example, damaged electronic equipment might catch fire. Also, pilots may receive incorrect information from digital instruments upset by EMP. Appropriate standing operating procedures (SOP) help mitigate secondary effects.

Both EMP and TREE can burn out electronic components or upset system operations. Upset conditions can occur at low signal levels because permanent damage occurs when currents induced by EMP and TREE exceed the capacity of a particular circuit within a system. Shielding sensitive electrical and electronic components is the best protection against burnout. For example, disconnecting antenna cables when the equipment is not in use is a recommended mitigation technique for EMP in field operations.

High-altitude nuclear bursts ionize the atmosphere and cause serious widespread blackout of high-frequency (HF) shortwave and synchronous satellite relay communications. Blackouts can last from a few minutes to several hours.

In highly ionized regions caused by low-altitude bursts, blackout interference generally decreases as EMP frequency increases. (Most EMP energy is at frequencies below 100 megahertz.) Blackouts from low air bursts are usually not significant. Dust-laden clouds from low air bursts cause blackout effects lasting from a few seconds to several minutes at most, and then only when a fireball or dust cloud blocks transmission paths. Actual interference depends on how many nuclear bursts occur, the altitudes at which they occur, and the areas over which they occur.

Units can reduce blackout by—

- Using wire communications systems. (However, a system with wires, especially long wires, is more susceptible to EMP.)
- Routing radio communications through a retransmission station or manual relay to bypass the blackout region.
- Assigning alternate frequencies. (If the signal operations (SO) officer suspects that an ionized region is producing interference, he tries higher

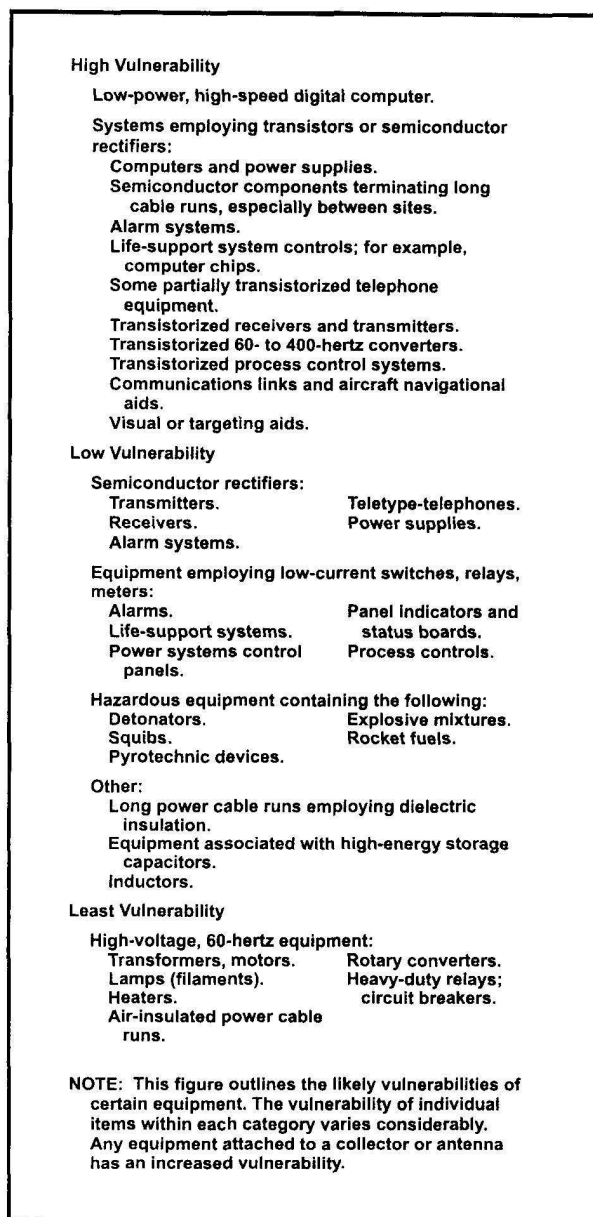

**Figure 2-1. Range of vulnerability to EMP effects**

frequencies first. When it appears dust is the problem, he tries lower frequencies.)

Figure 2-1 shows the range of vulnerability (which varies significantly within each category) for some common types of equipment. Communications equipment operators use the following general rules to make rough estimates of the electronic equipment's EMP vulnerability:

1. Any system that employs high-speed, integrated technology (such as personal computers) are considered vulnerable to EMP and TREE if operated in an unshielded environment.
2. Older equipment that uses discrete components of semiconductors and transistors are less likely to be susceptible to EMP damage than state-of-the-art equipment.
3. Equipment with large collectors is more susceptible to EMP damage than equipment with smaller collectors because the EMP energy collected is a strong function of the surface area exposed to EMP.
4. Unhardened radios operating at frequencies of 100 megahertz or below, such as HF systems, have a higher probability of EMP damage than communications equipment which operates at higher frequencies.

NOTE: None of these rules apply to EMP-hardened equipment. The hardness, or vulnerability level, of specific items of equipment is classified. For more information, see JP 3-12.2 (SRD).

## UNIT SURVIVABILITY

Survivability operations take on increased importance in a nuclear environment. The destructive power of nuclear weapons requires new measures to reduce vulnerability and to increase survivability. The commander must employ appropriate collective NBC protective measures given the unit's mission and the threat it faces.

NOTE: See also JP 3-12.1.

The commander also promotes survivability, at least to forward elements of close combat forces, by closing with the threat. Commanders should use a scheme of maneuver that contributes both to the combat objective and to survivability; for example, infiltrating at multiple points and conducting spoiling attacks.

Commanders must rapidly assess nuclear effects and determine appropriate actions and responses. The immediate impact on combat power can degrade the forces's ability to accomplish current and future missions. The commander must also determine long-term effects on future operations. Concerns at all levels are—

- Restoration of C<sup>2</sup>, intelligence, and logistic systems and capabilities.
- How the enemy exploits the nuclear strike.
- Decontamination of personnel and equipment.
- Combat health support (CHS) response requirements.
- Radiation exposure levels of subordinate units.
- Contaminated areas.
- Craters and obstacles created by blast and radiation effects.
- Protecting the force by adhering to OEG.

NOTE: See FM 3-4, Chapter 4, for a detailed discussion of individual protection.

Survivability operations, using sound active and passive protective measures and practices, are intended to protect friendly forces from the effects of enemy weapons systems. Sound survivability practices reduce a force's vulnerability to detection, to attack (if detected), and to destruction (if attacked).

However, measures to reduce vulnerability to one form of attack may increase vulnerability to other forms of attack and might detract from the overall effectiveness of the force. For example, dispersion may reduce vulnerability from nuclear attacks but increase vulnerability to infiltration and invite defeat in detail. Positioning (dispersion), mass versus dispersion, countermeasures, and mitigation techniques all lead to unit survivability.

### Positioning (Dispersion)

Positioning or dispersion can enhance survivability. However, dispersing combat units in direct proportion to a threat's nuclear weapons and yields is neither possible nor desirable. The degree of dispersion possible should be that which permits mission accomplishment while not subjecting the force to an unacceptable risk from attack. The difficulties with dispersion include movement of equipment, coordination, and supportability.

Although dispersion can enhance a unit's survival, it can also restrict tactical flexibility and inhibit mobility. Dispersion reduces vulnerability, but dispersion beyond the range of effective C<sup>2</sup> reduces combat power and increases the possibility of mission failure.

### Mass Versus Dispersion

Because measures that enhance survivability reduce combat power, the commander must carefully manage active and passive protection measures. (Dispersion is an example of the former, camouflage of the latter.) Protective measures contribute to battlefield success, but they cannot ensure it. Massing effects on a target rather than massing forces significantly reduces the risk to the command.

When a threat possesses nuclear weapons, US forces conduct operations in anticipation of their use. The commander maintains his ability to disperse forces as rapidly as he massed them or he will present a lucrative nuclear target. This is the mass versus dispersion dilemma.

NOTE: See FM 3-3-1 for tactics, techniques, and procedures (TTP) on solving the mass versus dispersion dilemma.

### Countermeasures

An antagonist having sophisticated intelligence systems is a great threat because it can—

- Monitor friendly communications.
- See the battlefield from overhead.
- Locate emitters and control agents deep in rear areas.

Countermeasures employ devices or techniques to impair the operational effectiveness of an enemy's activities. Countermeasures might include—

- Operations security (OPSEC), which can prevent the enemy from obtaining information about Army operations.
- Deception, which can prevent the enemy from obtaining unit location and activity information.
- Information security, which can prevent disclosure of information about unit locations and activities from written, verbal, and graphic communications sources.
- Physical security, which can prevent equipment signatures, profiles, and patterns.
- Signals security (SIGSEC), which can protect nuclear operational information by using

communications security (COMSEC) and electronic security (ELSEC) techniques.

- Analysis of information gathered through intelligence operations to predict enemy intentions.

### Mitigation Techniques

Mitigation techniques are expedients the force accomplishes using only equipment and material available on the battlefield. Mitigation techniques will not totally overcome nuclear vulnerability. However, used wisely, they can lessen the vulnerability of personnel and equipment to nuclear-weapons effects. Techniques may be as simple as using anchors, tiedowns, and outriggers to build shelters; using equipment at hand to dig shelters; or using tracked vehicles as overhead cover. Techniques may also include wetting down or compacting defensive positions to enhance radiation protection.

Measures that provide security against detection also often provide some protection against nuclear attack or can minimize nuclear-weapons effects. One measure is terrain shielding, which minimizes the risks of detection as well as reducing the extent and severity of nuclear-weapons effects.

Any cover, including natural vegetation, significantly reduces thermal radiation effects and may even diminish the intensity of nuclear radiation. Hills and folds of ground between the unit and the detonation can somewhat reduce nuclear effects. Natural and man-made terrain features (individual fighting positions with overhead covers or buttoned-up armored vehicles) can also modify blast waves and lessen nuclear effects.

## EQUIPMENT SURVIVABILITY

Equipment survivability in a nuclear environment begins with the materiel-acquisition process before hostilities begin. Equipment must be able to withstand the initial effects of a nuclear weapon and still accomplish its mission.

The commander should not confuse nuclear survivability with NBC-contamination survivability. The latter is the capability of a system and its crew to withstand an NBC-contaminated battlefield, in-

cluding one with residual ionizing radiation, without losing the ability to accomplish its mission.

The Army's goal is for soldiers who survive exposure to nuclear-weapons effects to retain their mission-essential equipment in a condition which would enable them to complete their missions. Equipment failure must not disarm soldiers who could otherwise continue their missions.

### Methods and Techniques to Enhance Survivability

Units can ensure the survivability of their equipment by—

- Avoidance (using mobility, concealment, and deception to avoid attack).
- Redundancy (proliferating so many systems or components on the battlefield that the loss of a few would not affect the mission).
- Reconstitution (possessing the ability to repair or replace equipment on the battlefield in enough time to complete the mission).
- Mitigation (employing field-expedient techniques which soldiers and units can readily accomplish using only what is available).
- Hardening (designing equipment to withstand exposure to nuclear-weapons effects).

The best approach to equipment survivability is usually some combination of these means. The commander should consider all of them. Some means increase survivability against conventional as well as nuclear threats. Nonetheless, given the unique and often far-reaching effects of nuclear weapons, some degree of nuclear hardening is the best approach in most instances.

Balanced survivability is the essence of the Army's philosophy. Survivability of mission-essential equipment must be balanced with that of crew survivability. It implies specific requirements to make crew-served equipment or systems as survivable as the crew—but no more survivable than the crew—and only in environments of tactical significance.

NOTE: See FM 3-3-1 for detailed TTPs for nuclear-contamination avoidance.

Time After Detonation		
Less than a second	Less than a minute	Minutes/hours /days
<b>Nuclear Effects</b>		
Prompt gamma rays	Airblast	Fallout
Electromagnetic pulse	Ground shock	Residual radiation
Neutrons	Dust/pebbles /debris	Communications/ radar blackout
Initial thermal radiation	Cratering	Firestorms
		High-altitude dust
Major portion of the thermal radiation		

**Figure 2-2. Arrival times of nuclear effects**

### Nuclear Environment Arrival Times

The commander must also be aware of the arrival times of different nuclear effects on the battlefield. This knowledge is critical to a system's response and survivability. Nuclear effects fall into three general time frames:

1. Effects which almost instantaneously arrive after detonation.
2. Effects which arrive within the first few seconds to minutes.
3. Effects which typically take from minutes to hours or even days to arrive.

NOTE: See Figure 2-2.

### DYNAMICS OF COMBAT POWER

The dynamics of combat power—maneuver, fire-power, protection, and leadership—are vital. Nuclear-weapons use by either side adds another dimension to each of these elements. Nuclear weap-

ons greatly increase a force's warfighting potential, but they can also present new operational challenges and dilemmas. Figure 2-3, page 2-8, describes how each of the basic effects of a nuclear weapon affects the four dynamics of combat power.

NOTE: See FM 100-15 for an in-depth discussion on the dynamics of combat power.

Possibly the greatest, and least understood, challenge confronting the Army is how to accomplish the mission following nuclear-weapons use. This challenge is difficult but not impossible; the key is the quality of leadership and the capability to operate in a nuclear environment.

Leadership and training may prove to be the deciding factor in future conflicts. Knowledge of the special physical and psychological hazards of the nuclear battlefield, and doctrinal guidance and training to counter these hazards, greatly improves the Army's ability to operate successfully.

### SUMMARY

Commanders and their staffs understand that, when planning operations, the use or possible use of nuclear weapons has specific, tangible implications that go beyond the actual effects of a detonation. Nuclear weapons are highly destructive and have harmful effects that other weapons do not have. Commanders must plan for and implement measures to mitigate such effects.

Commanders must also know how nuclear-weapons effects can affect personnel, equipment, and the dynamics of combat power. They must plan for and implement survivability measures and techniques. Their confidence and leadership may be the deciding factor in how their soldiers survive and succeed in a nuclear environment.

NOTE: See JP 3-12.2 (SRD) for a more in-depth discussion of nuclear-weapons effects and responses. Additional detailed, unclassified data is in DA Pam 50-3. Additional classified data is in the Defense Nuclear Agency Effects Manual (DNA EM-1) (SRD), Chapter 17, Section IV.



Dynamics of Combat Power	Initial Blast	Actions			
		Residual Radiation	Radiation	Thermal	EMP
Maneuver	Creates obstacles	Creates NIGA (note)	Creates fallout	Creates flash blindness	Disrupts C <sup>2</sup> Disrupts intelligence Disrupts logistics
Firepower (target nomination)	Destroys equipment	Produces latent ineffectiveness on deep targets	Minimizes fallout (low air burst)	Not used	Disrupts fire control instruments
Protection	Destroys equipment	Kills soldiers	Causes fallout considerations	Increases survivability concerns	Increases mitigation requirements
Leadership	Produces mass casualties	Increases radiation status of units	Causes psychological effects on soldiers	Increases the complexity of triage with burn and blast injuries	Results in loss of C <sup>2</sup>

NOTE: Neutron-induced gamma activity.

**Figure 2–3. Basic effects of nuclear weapons on the dynamics of combat power**

## Chapter 3

# PLANNING NUCLEAR OPERATIONS

## JOINT NUCLEAR OPERATIONS

Joint and multinational operations become more risky with the threat of the enemy's use of weapons of mass destruction. The likelihood of an enemy using weapons of mass destruction decreases as US and coalition forces demonstrate their ability to defend against such effects and to react to attacks with nuclear weapons. The threat of nuclear-weapons use creates unacceptable risk to the enemy. That, combined with the will to react if necessary, is the basis for US nuclear deterrent policy.

Countries that cannot protect themselves against nuclear weapons may become the primary targets of an enemy whose aim is to disintegrate a coalition force. If necessary, the US armed force reserves the right to employ all of its assets, including nuclear weapons, to support coalition needs. Therefore, nuclear warfare is most likely during a major regional crisis versus a lesser conflict.

Commanders must consider the aforementioned possibilities in all strategic, operational, and tactical planning. They must also evaluate—

- The availability of joint nuclear resources.
- Ways of attaining military objectives.
- The ability to credibly threaten an enemy's high-payoff targets (HPT).
- The risks of enemy nuclear counterattack.
- Any potential change in a regional military balance of power.
- The consequences of a nuclear-nomination denial.
- Any reduction in a threat's ability to conduct operations or opportunities to prevent him from undertaking future military action.
- The consequences of failure in the execution of a nuclear strike.
- The results of nuclear effects on the target.

Aggressive interface between intelligence and acquisition systems, nuclear planners, operations planners, and delivery systems in the joint environment ensure targets are struck at the decisive point and time. This is the essential element of successful joint operations. Considerations for nominating nuclear weapons in a theater of operations include—

- Enemy use of NBC weapons.
- Lack of conventional containment of enemy forces.
- Survival of the force from mass attack.
- Support of other strategic options.

The corps commander and his superiors amplify the following points when nominating nuclear weapons:

- That the enemy has used, or there are indications that he will immediately use, nuclear weapons.
- That the friendly force is facing overwhelming enemy conventional forces and cannot survive unless it uses nuclear weapons.
- That the friendly force might require nuclear weapons to accomplish the campaign plan.

The decision to authorize nuclear-weapons employment is the exclusive prerogative of the President. The theater CINC requests the release of nuclear weapons from the NCA if he determines the situation requires their use. The NCA's control and constraint of nuclear weapons include seven elements:

1. A decision to use nuclear weapons.
2. The number, type, and yields of weapons.
3. The types of targets to be attacked.
4. The geographical area of employment.
5. Timing and duration of employment.
6. The level of damage to be inflicted on the enemy.
7. Target-analysis methodology.

All nuclear weapons are bound by the same US nuclear policy constraints. Moving nuclear weapons from peacetime locations to a theater that does not have nuclear weapons requires NCA approval. Moving weapons within a theater is limited by guidance set forth in a positioning-approval document.

A nuclear-warfare battlefield requires commanders to conduct continuous operations before, during, or after nuclear-weapons detonation. Army nuclear operations have mostly operational and tactical implications; execution has strategic implications. Characteristics of Army nuclear operations include—

- A lack of Army organic nuclear fire support.
- Dependence on Air Force and Navy assets to provide nuclear support to Army operations.

- The highest level Army headquarters in theater is the focal point for Army nuclear-target nomination.
- Continued operations in a nuclear environment.
- Force protection, which is imperative in a nuclear environment; units can survive the enemy’s use of nuclear weapons by anticipating employment.

### The Deliberate-Planning Process Planning Guidance

The nuclear deliberate-planning process is the series of actions planners take to develop nuclear support that sister services will provide. Planners use the Joint Operations Planning and Execution System (JOPES) in the deliberate-planning process to develop nuclear support plans (Figure 3-1). An

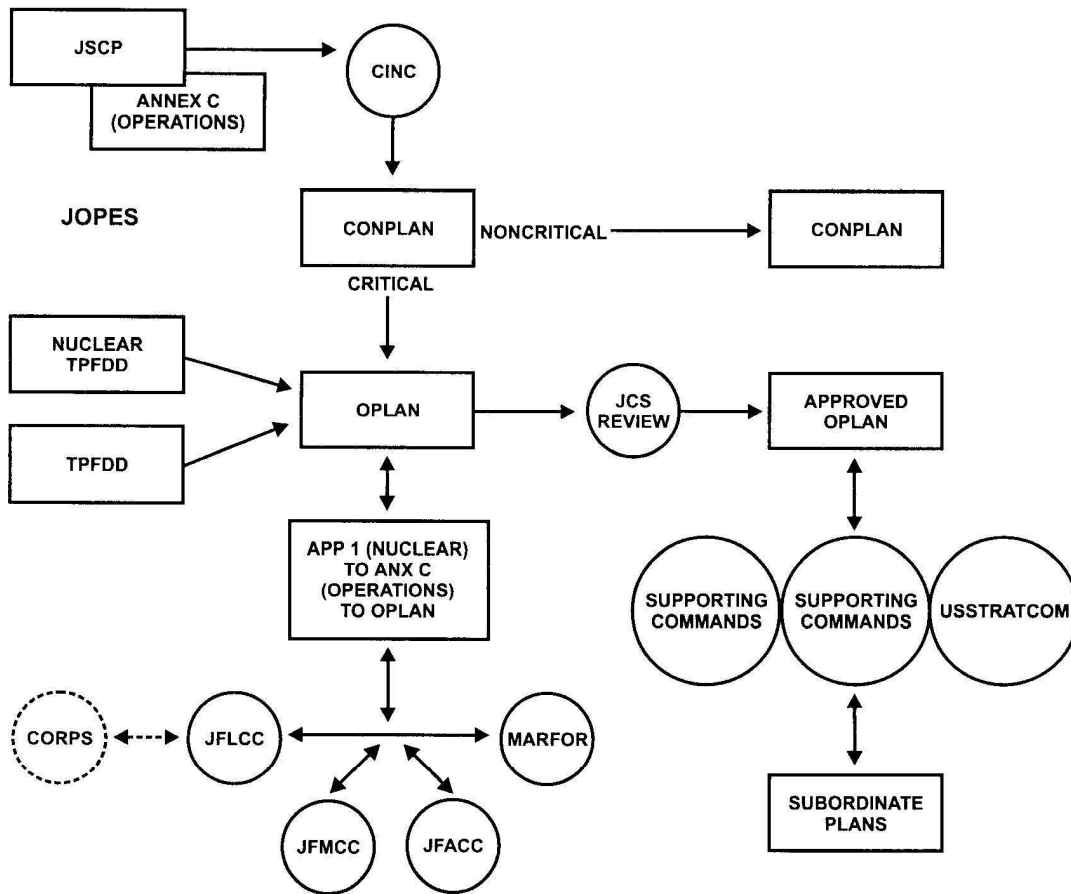

NOTE: See Glossary for explanation of acronyms.

Figure 3–1. Deliberate-planning process (nuclear)

example of deliberate planning is the process the commander and staff use when contemplating the possible use of nuclear forces in force projection.

During the deliberate-planning process, the combatant command staff develops the concept plan (CONPLAN) and coordinates it with the various subordinate commands and services. When directed, the combatant command staff develops an operation plan (OPLAN). (Subordinate commands develop and coordinate supporting OPLANs.)

During the process, the staff coordinates the nuclear appendix of the operation annex to the OPLAN with corps and various commands. The corps, through the joint force land component commander (JFLCC), Army forces (ARFOR), or joint task force, provides input to Appendix 1 (Nuclear) to Annex C (Operations) of the OPLAN. The joint force maritime component commander (JFMCC) and the joint force air component commander (JFACC) also provide input to Appendix 1. The product of this coordination is the theater OPLAN.

NOTE: Both the CONPLAN and the OPLAN must conform to current procedures. See JP 5-03.1, Volume (Vol) I, for more information.

While developing the OPLAN, planners consolidate nuclear requirements into a separate, stand-alone, time-phased force and deployment data (TPFDD) document. The Army and the other services participate in this process to make sure they have considered all reasonable options and have met all requirements.

Echelons below the CINC may or may not participate in the nuclear decision-making process. When Army echelons subordinate to the CINC are involved, the procedures in this manual apply.

## Targeting

Within the theater, the targeting of nuclear weapons may happen in one of three ways:

- The theater CINC can conduct planning, targeting, and execution without consulting the subordinate commander.
- The theater CINC can inform the functional component commander of what nuclear weapons are available and provide planning guidance for target nomination.

- The targeting selection can come directly from the continental US (CONUS) based on the CINC's requirements.

## The Crisis-Action Planning Process

Nuclear planning begins during peacetime. During a crisis, Army commanders use the crisis-action planning process to modify or expand existing plans as needed. For the Army, the nuclear crisis-action planning process includes determining requirements and developing options for support.

When contemplating the use of nuclear weapons, based on threat and operational considerations, the CINC decides whether the JFLCC needs nuclear support. He then directs the appropriate air or maritime component commanders to develop a crisis-action plan. USSTRATCOM assists the CINC in the crisis-action planning (CAP) process. He then issues his OPORD. This phase is the execution-planning phase. The JFLCC and the corps develop supporting plans to enhance the nomination process (Figure 3-2, page 3-4).

## Force Projection

### The Stages of Force Projection

Force projection operations are inherently joint and usually begin as a contingency operation in response to a crisis situation. Force projection has eight stages: mobilization, predeployment activities, deployment, entry operations, war termination and postconflict operations, redeployment and reconstitution, and demobilization. (See FM 100-7 and FM 100-15 for details.)

### Entry Operations

There are two types of entry operations—unopposed and opposed. Before either entry operation begins, the G2 determines the enemy's WMD capability. This knowledge, as well as the degree of opposition the commander can anticipate, influences the selection of which type of entry operation he will use.

Unopposed entry operations have specific meanings to a corps that this manual does not discuss. Opposed entry operations may often be the initial phase of a campaign. Commanders make maximum use of joint capabilities to ensure early lethality and

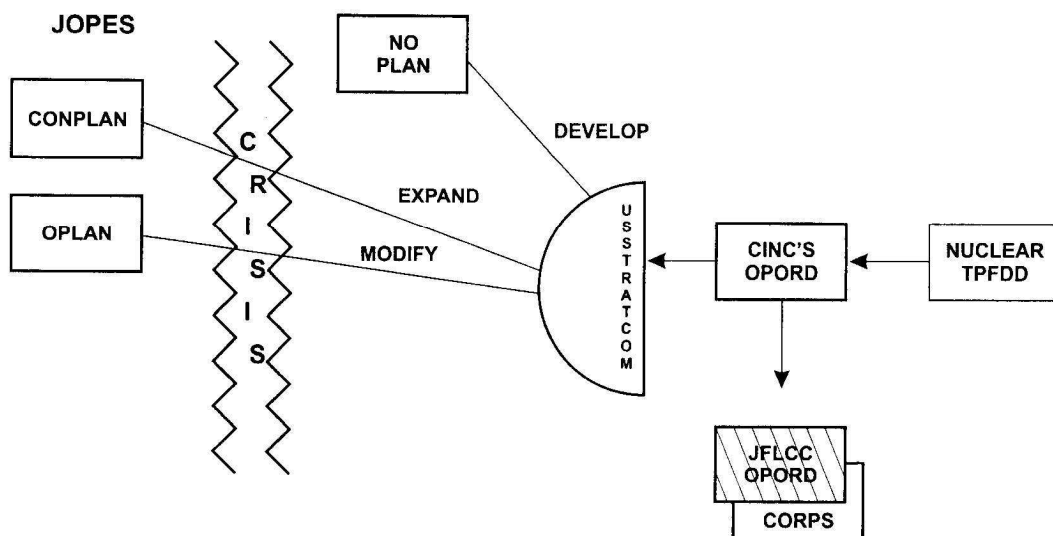

Figure 3-2. Crisis-action planning process (nuclear)

force security. Opposed operations occur in one of three ways: raids, lodgements, or by coup de main. Raids are small-scale operations and should not require nuclear use.

Lodgement operations require forces to seize an airhead or beachhead. The intent is to create maneuver room and to provide for the continuous entry of forces and materiel for subsequent operations. During a lodgement, the commander would normally nominate targets (such as enemy counterattack forces or C<sup>2</sup> facilities) based on a low minimum safe distance (MSD) corresponding to negligible risk to unwarned exposed personnel. Applying safety and collateral-damage preclusion data to the operations maps depicting the forward line of own troops (FLOT) helps ensure troop safety. Combined with the target-analysis process, the data ensure that the targets which commanders nominate are truly HPTs and that the force meets troop and civilian safety requirements. The NCA makes the political decision if the loss of the lodgement is more acceptable than is the use of nuclear weapons.

NOTE: See JP 3-12.2 (SRD) for more information on the target-analysis process.

A coup de main, as used in this manual, is an offensive operation that capitalizes on surprise and simultaneous execution of supporting operations to achieve success in one swift stroke. For example, a coup de main combines entry and combat operations to achieve the opposed entry aspect of theater strategic objectives in a single major operation. The

coup de main is the preferred means of conducting opposed operations. Using overwhelming combat power against a foe means rapid mission accomplishment, fewer casualties, and minimal collateral damage.

The main objective of nominating nuclear weapons during coup de main operations is to destroy the enemy's weapons of mass destruction. Additional nuclear weapons are nominated against facilities and major troop concentrations.

Nuclear-weapons use during a coup de main enhances strategic objectives rather than tactical objectives. The nuclear weapons nominated might be further from the FLOT than in lodgement operations.

Stage five is the operations stage. It consists of missions that lead to or directly contribute to accomplishing the CIN's campaign objective. (See Chapter 5.)

Stage six is war termination and postconflict operations. The fundamental differences between a potential nuclear war and previous military conflicts involve the speed, scope, and degree of destruction inherent in nuclear weapons employment as well as the uncertainty of negotiating opportunities and enduring control over military forces.

Depending on the scope and intensity of a nuclear war and how and under what conditions it is brought to a conclusion may be quite different from previous wars. The objective of termination strategy should

be to end a conflict at the lowest level of destruction possible consistent with national objectives. United States nuclear forces supporting command, control, communications, computer, and intelligence (C<sup>4</sup>I) systems and employment planning must provide the capability to deny enemy war aims, even in a conflict of indefinite duration.

Stage seven is redeployment and reconstitution. See Chapter 6 for a discussion of the nuclear aspects of reconstitution. See FM 100-15 for a discussion of redeployment aspects.

Stage eight is demobilization. In this stage NBC defense units that mobilized during stage one demobilize.

NOTE: See FM 100-17 for a detailed discussion.

### THE CORPS AS A JOINT TASK FORCE

When the corps commander is the commander of the joint task force (CJTF), he—

- Passes guidance for joint nuclear support to subordinate commanders.
- Defines and implements a methodology for joint planning.
- Prioritizes missions and targets.
- Allocates resources to accomplish the mission.
- Through his concept of operations, specifies the required objectives.
- Task-organizes the joint force to accomplish the mission.
- Establishes communications and automation architecture to support joint fire support activities.
- Establishes constraints and conditions for nuclear employment.
- Decides whether or not to create a joint targeting coordination board (JTCB) and what it will include.

When the corps commander is *not* the CJTF, he—

- Nominates nuclear targets.
- Ensures that corps representation on the JTCB (when established) is adequate to meet the needs of all subordinate corps elements.

- Identifies requirements, nominates targets, and employs maneuver control and fire support coordination measures (FSCM) to facilitate joint operations.

The JTCB—

- Reviews target information. (Each echelon of command consolidates, evaluates, and passes up the chain of command proposed targets for review, which are subsequently forwarded for approval.)
- Deconflicts targets among members.
- Develops priorities on guidance.
- Prepares target lists.
- Allocates resources to weight the main effort.
- Synchronizes the delivery of joint fires to support the OPLAN.

### JOINT NUCLEAR-WEAPONS EMPLOYMENT SUPPORT

#### The Planning and Execution Cycle

When the corps and/or EAC plan nuclear-target nomination, planners go through a joint nuclear-weapons employment support planning and execution process (Figure 3-3, page 3-6). A typical scenario might be as follows:

- The corps and/or EAC plan targets for nuclear-weapons nomination.
- The US Army Nuclear and Chemical Agency (USANCA) maintains nuclear employment augmentation teams (NEATs) that will deploy to augment the nuclear-weapons planning staff of Army headquarters at corps or EAC during periods determined by the senior Army commander.
- The NEATs (one per major regional contingency)—
  - Provide expert advice to the commander on all aspects of nuclear operations.
  - Work closely with the strategic liaison assistance team (STRATLAT) to ensure an Army/joint interface in theater nuclear matters.

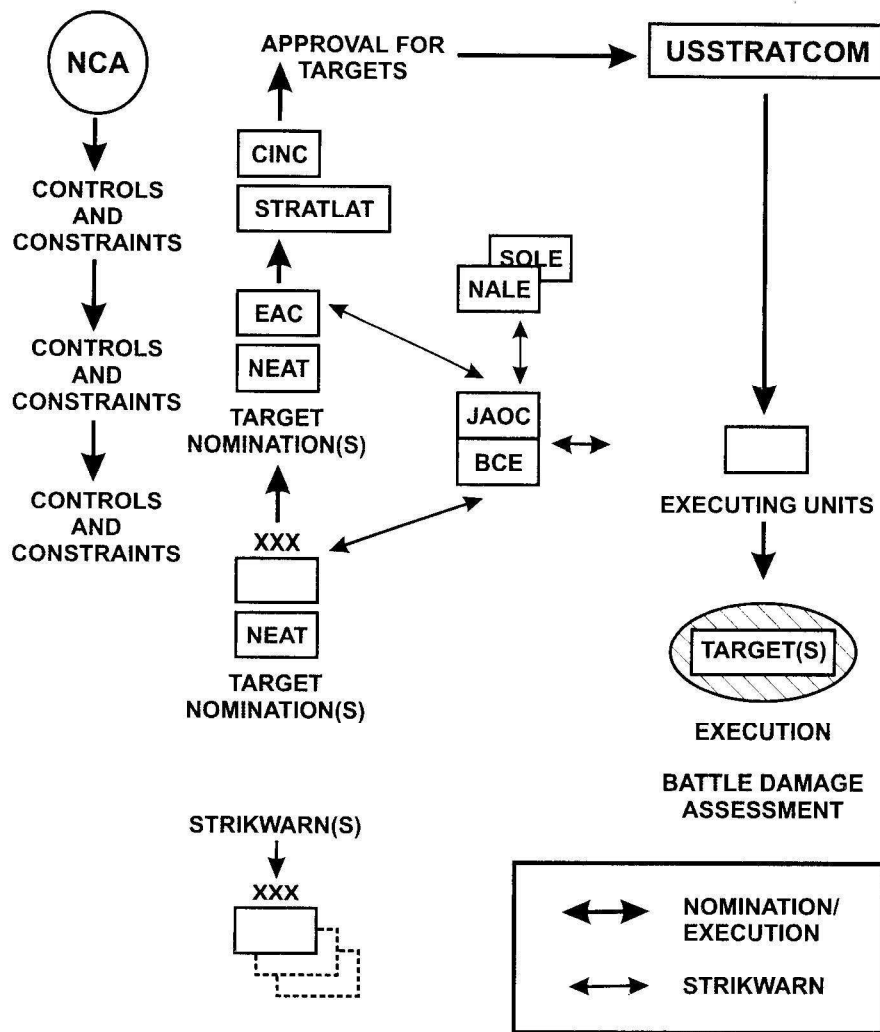

NOTE: See Glossary for explanation of acronyms.

Figure 3-3. The joint nuclear-weapons employment support planning and execution process

- Generally deploy at approximately the same time as STRATLAT deployment (but always at the senior Army commander's request).
- Are available at all times to assist Army planning staffs at corps level and above in nuclear matters (including orders preparation, exercise participation, OPLAN development, and other staff assistance as required) at the commander's request.
- Depend on the supported unit for logistic support, communications, and integration into the unit's reconnaissance, selection, and occupation of position (RSOP) plan and the unit's deployment plans.
- The JFLCC provides the corps with—
  - The numbers, types, and yields of nuclear weapons available for target planning and target nomination.
  - Geographical areas for nominating targets.
  - Duration of employment time.
  - Types of targets to nominate.
- The echelons above corps (JTF, JFLCC, ARFOR) consolidates, deconflicts, and refines the corps' nomination and incorporates the desired target into its own plans as options, then forwards

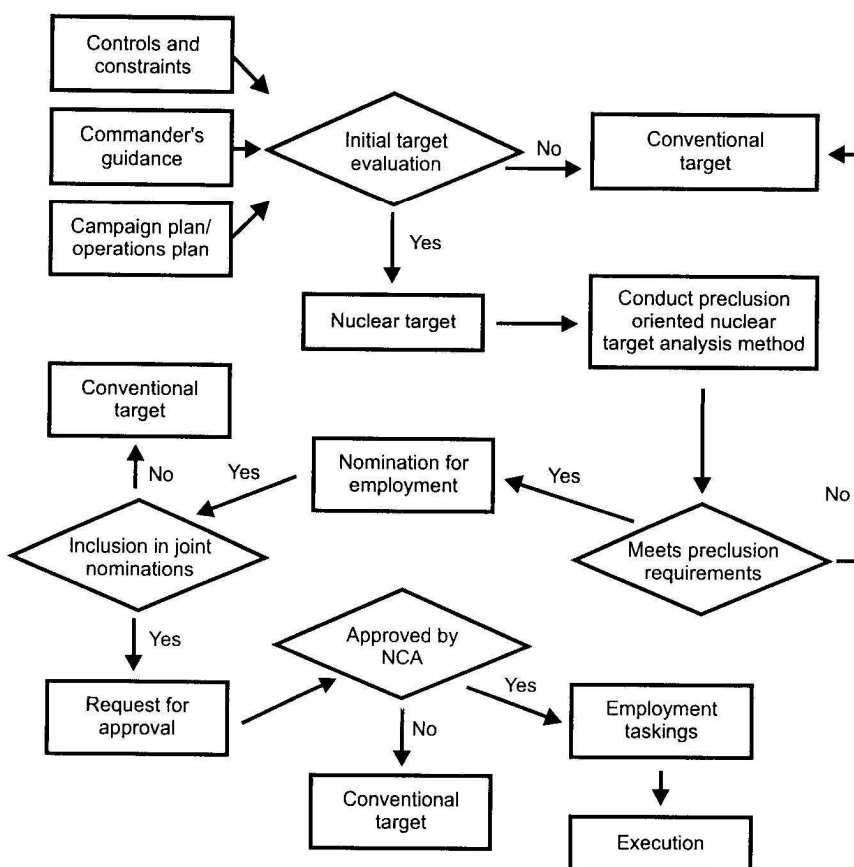

Figure 3-4. The nuclear target-analysis nomination sequence

the options to the theater CINC to consider during employment planning.

- Each headquarters integrates nuclear options into its OPLAN to maximize all available combat power; commanders at each level merge, purge, and coordinate the options to deconflict and optimize the effects of nuclear nomination (Figure 3-4).
- The US Strategic Command (USSTRATCOM) CINC is the supporting commander to the theater CINC in the area of nuclear operations and provides, at the theater CINC's request, a STRATLAT—
  - To perform all nuclear functions for the theater CINC, including preparing the nuclear portion of all orders.
  - To process the nominated targets and, with the theater CINC's approval, transmit the information to the NCA (via USSTRATCOM) for presidential approval.
  - To provide adaptive planning and analysis capability, as well as all other requisite nuclear requirements, to the theater CINC.
- The NCA, which provides controls and constraints for nuclear-weapons use in theater, returns the approved plan to the CINC.
- The CINC passes the approved plan down to the JFLCC and corps commander and may provide them with controls and constraints for option planning and target nomination.
- The theater CINC coordinates with JFLCC headquarters for target-location refinements and to provide information for nuclear strike warnings (STRIKWARN).
- The air component commander (ACC) passes strike information through the battlefield coordination element (BCE) to Army elements.



- The BCE, which is the Army's coordination element at the JFACC's air operations center (AOC)—
  - Monitors and analyzes the land battle.
  - Provides interface for exchanging current intelligence and operational data between air and land components.
- The air defense artillery (ADA) and Army air-space command and control (A<sup>2</sup>C<sup>2</sup>) sections of the BCE support Army and Air Force interface as needed.
- The airspace control authority (ACA) (normally the JFACC) ensures deconfliction of other air assets for the proposed nuclear strike.
- Air and naval delivery systems require airspace coordination to ensure control of friendly air defense (AD) assets and to ensure the suppression of enemy air defense (SEAD) assets.
- To minimize friendly casualties, all commanders tasked with execution planning—
  - Deconflict force locations.
  - Plan around effects on communications.
  - Ensure they have the means to keep all other commanders informed of unit locations.
- The Navy amphibious liaison element (NALE) collocates with the AOC and coordinates Navy and Marine components.
- The special operations liaison element (SOLE) coordinates the other elements with the special operations forces (SOF).
- The special operations coordination (SOCOORD) element, if they are to be affected, because of their possible proximity to the desired ground zero (DGZ), receives advance notice of an impending nuclear strike.
- Sister services (Air Force and Navy) provide the delivery means and weapons systems (aircraft and missiles) that support land forces during nuclear operations.

This planning cycle is continuous and dynamic. Employment planning may change as weapons, threat arrays, and population centers change. For example, during wartime, the JFLCC and corps commander continue to refine and update target

nominations based on the campaign plan and the operational situation.

The execution of a sister service nuclear mission within each corps is based on theater guidance. Corps and JFLC commanders augment this guidance with their own planning cycle. A sample theater nuclear-weapons nomination sequence begins at corps and processes up through the chain of command to the NCA and back down to the JFACC and/or JFMCC (Figure 3-5, page 3-9). Figures 3-6 and 3-7, page 3-10, show a sample of a corps 96-hour planning cycle. The NCA must approve all political decisions before this process is initiated.

NOTE: See JP 3-12.2 (SRD) for detailed delivery and weapons data. The publication also contains classified sister service systems capabilities and employment considerations such as accuracy data and reaction times. It also provides nuclear-targeting guidance. Joint Publication 3-12.1 provides the advantages and disadvantages of using the various weapons systems.

### Coordination

Coordinating actions and responsibilities is extremely important in nuclear operations. Specific functions and activities involve forces from two or more services or two or more forces of the same service. Therefore, coordination must begin immediately after mission receipt and continue throughout the operation.

Coordination is essential because subordinate commanders and staffs must share pertinent information and have as much time as possible to prepare and rehearse plans. (See Chapter 4.) Units at every level must have time to conduct route reconnaissance, rehearsals, and multiple activities to adjust coordination details and timing and the synchronization plan accordingly. When properly done, subordinate commanders' intents and concepts of operations support and complement the higher commander's plan.

Coordination for nuclear-weapons nomination closely follows established interdiction procedures for conventional support. In multinational operations, agreements may require modifications of established US Army doctrine. In joint operations, the JFLCC and corps commander integrate nuclear-weapons nomination into conventional operations

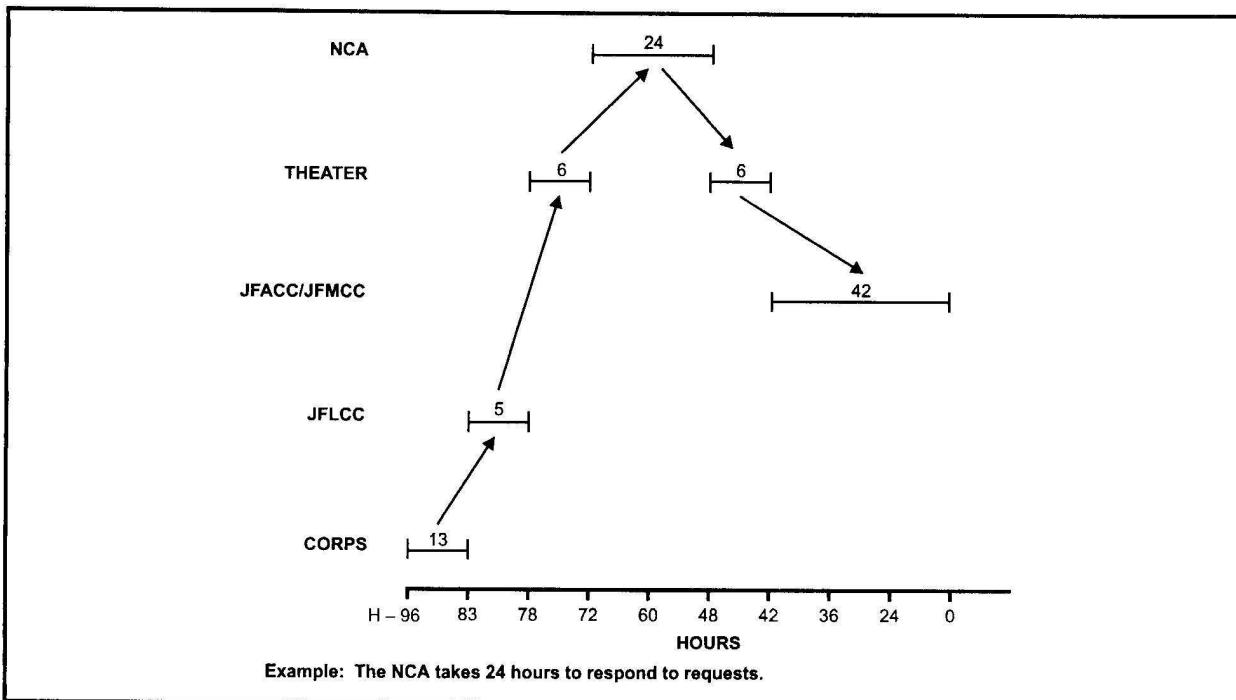

Figure 3-5. A sample theater nuclear-weapons nomination sequence

0100	0400	0600	0700	0800	1100
Campaign coordination meeting.	New ATO in effect.	CTOC passes HPT to FSE.	Guidance for nuclear nomination.	1. Deep attack cell meets to review HPT and make recommendation. 2. Target analysis.	Targeting board meets and approves corps nominations.
1130	1200	1300			
Joint assessment group coordinates meeting.	Corps commander's approval.	Corps nomination passed to JFLCC.			

Figure 3-6. A sample corps nuclear-weapons nomination cycle

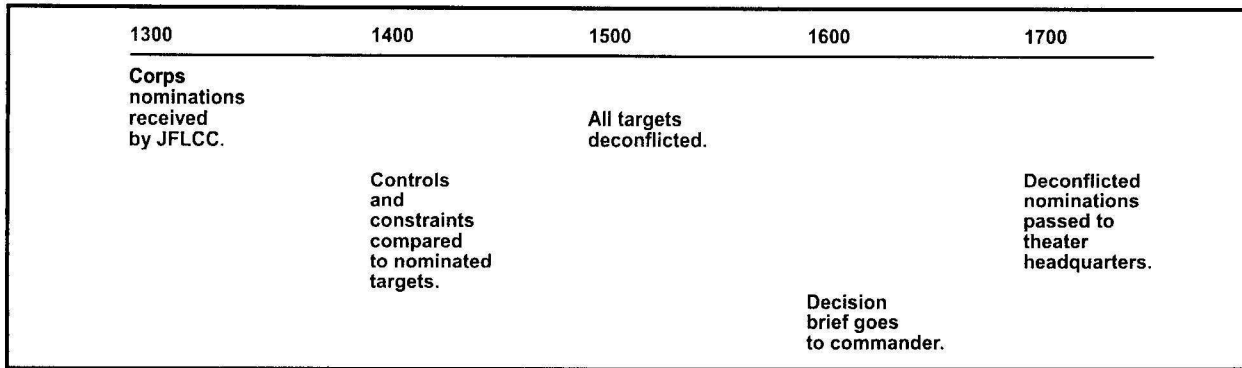

Figure 3-7. A sample JFLCC nuclear-weapons nomination cycle

without using special phases and transitions or creating a signature for a threat to observe.

The corps commander provides input to the CINC for any nuclear operations within his area of operations. Therefore, he must be aware of all aspects of nuclear strikes within the CINC's area of responsibility. Strikes require control agreements between the corps commander and the JFLCC and the JFACC. The JFACC informs the corps commander through the BCE of the timing and locations of strikes as they affect Army operations.

Lateral coordination between units is as important as vertical coordination. The corps nuclear, biological, and chemical center (NBCC) transmits lateral troop-safety information to adjacent corps. If time is limited, the corps fire support cell transmits safety information to the adjacent divisions first. The NBCC then notifies the adjacent corps.

Figure 3-8 depicts an example of this safety information. The diagram assumes a linear battlefield and is for illustration only. It shows the X Corps passing information to the VII Corps on its left. Using the same methodology, Figure 3-9, page 3-11, depicts a noncontiguous battlefield. Both battlefields would be on the nuclear overlay to the operations map.

### Contingency Operations

Contingencies require plans, rapid response, and special procedures to ensure the safety and readiness of personnel, intelligence, and equipment. The CINC can direct a corps commander to deploy his forces as part of a contingency force. The corps commander may then become the CJTF of the contingency force. The CJTF coordinates all nuclear-

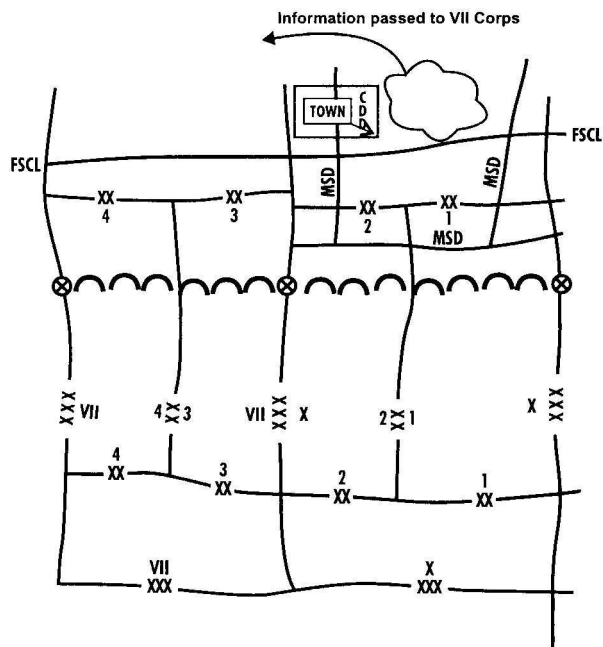
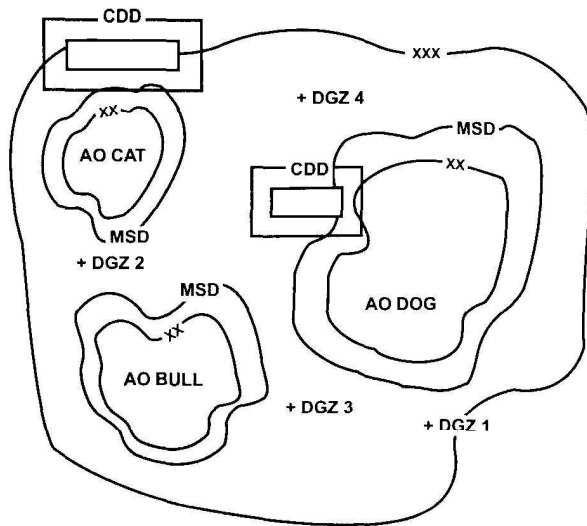

Figure 3-8. The linear battlefield

weapons employment within the contingency force's area of operation. Coordination of fires must follow established joint procedures.

The CJTF develops plans, including those for nuclear weapons, during the early stages of hostilities. Plans must be flexible enough to support the contingency mission. However, employing nuclear weapons early in an operation may not be feasible, desirable, or necessary. As the theater matures, the CINC may time-phase nuclear weapons to arrive at



**Figure 3-9. The noncontiguous battlefield**

the optimum time to support combat operations or for deterrence.

Regardless of the area into which the unified commander deploys a contingency force, some multinational operations are inevitable. When authorized by the NCA and/or the CINC, the CJTF advises coalition and alliance force commanders of plans to deploy nuclear weapons to the area of operations or of plans to employ them.

## MULTINATIONAL OPERATIONS

Multinational operations are operations that two or more forces or agencies of two or more nations acting together conduct to accomplish a single mission. Existing alliances, established over a long period of time, or ad hoc coalitions, formed as a rapid response to unforeseen crises, might have to undertake multinational operations to protect their common interests. Liaison officers from nuclear-capable allied countries advise the commander of the joint force on their nation's stated nuclear policy.

The key to successful multinational operations is mutual trust and confidence. United States commanders who work with allied or coalition forces must understand how the use of nuclear weapons

would affect political, economic, informational, and military operations. The senior US combatant commander in a multinational command gives guidance and publishes directives on nuclear-weapons use by US forces in such commands. His guidance includes—

- Tasking responsibilities across countries.
- Resolution of conflict between multinational forces.
- Target selection.

Despite sustained efforts in the field of arms control, there is firm evidence of a continuing, worldwide proliferation of weapons of mass destruction and their associated means of delivery. Therefore, future world leaders must plan, conduct, and support multinational operations against a background of a continued risk of hostile forces employing such weapons.

Principal factors affecting multinational operations under a threat, or following the use of nuclear weapons, include—

- Intelligence. The intelligence officer makes a current, comprehensive, and accurate intelligence assessment of nuclear threat in the theater of operations.
- Availability of NBC defense equipment. Commanders must be aware of the NBC equipment available to multinational forces.
- Training standards. Commanders must be aware of any limitations in their forces' training and of any experience that units have had in operating under real or simulated NBC threat conditions.
- Updating threat assessments. Multinational commanders constantly review the NBC threat and promulgate regular, updated threat assessments so subordinate commanders can make informed decisions on the minimum protective measures needed.

NOTE: See also Allied Tactical Publication (ATP) 35A. See JP 3-12.3 for a description of the analysis process. Standardization agreements (STANAGs) and understood terms are used in multinational operations. For example, the term "nuclear safety line" is not used in US doctrine, but may be used by a multinational headquarters.

## PLANNING JOINT NUCLEAR OPERATIONS

At the operational level of war, the commander must consider several factors as early as possible when planning multinational operations. He must—

- Have a reasonable understanding of his ally and coalition forces' equipment, doctrine, and capabilities.
- Ensure that the force understands NCA controls and constraints and the commander's intent for nuclear-weapons nomination.
- Ensure that OPLANs clearly state controls and constraints.
- Work closely with J3 or G3 operations personnel to prevent fratricide or collateral damage.
- Work with other staff sections to prevent violation of any political or military restrictions on nuclear-weapons employment.
- Integrate conventional-weapons employment, including air and naval systems and operations with nuclear-weapons nomination. (Combining both weapons types, as well as varying operational options, creates a synergistic effect.)

The planning process is continuous and congruent. Planning factors include—

- The strategic situation (the ability of friendly forces to defeat targets using available conventional means).
- The type and extent of operations (the numbers and types of individual targets).
- Damage-limitation measures (target vulnerability).
- The environmental impact (low-air burst versus surface burst).
- Alert posturing (weapons availability either in or out of the theater).
- The enemy's ability to reconstitute or regenerate his forces.

### Command Guidance

Command guidance is the focus of nuclear planning at any level. It includes—

- Intent of nuclear-weapons nomination (a statement of the desired results).
- Synchronizing the scheme of maneuver and other means of attack such as conventional fires and electronic attack.
- Target priorities.
- Delivery systems, weapons, and yields available for planning.
- Acquiring targets through all available means, including national assets.
- Troop-safety limitations and civilian-preclusion criteria.
- Fallout restrictions.
- Collateral-damage preclusion criteria.
- Impact of nuclear-weapons effects on future operations.
- Counterstrike targets considerations.
- Decision points (DPs) for recommending nuclear targets.
- STRIKWARN transmittal to friendly units.
- Contingency planning.
- Deconfliction.
- Post-strike damage assessment requirements.

Based on the nuclear weapons damage assessment, the commander can—

- Continue the operation as planned.
- Reallocate combat assets to continue the operation.
- Recommend another nuclear strike.
- Implement a contingency plan if the tactical situation dictates.
- Determine obstacles that will affect the scheme of maneuver.
- Protect the force by adhering to the operational exposure guide.

Commanders may amplify or modify guidance (within NCA and/or higher headquarters guidance) when the evolving battlefield situation calls for a change in plans. Nuclear-weapons use should be restrictive, with tight political limits so the enemy

will recognize the controlled escalation "signal" and not assume that we have moved to general war. The following are considerations that accomplish this "signal":

- Tight limits on the area of employment.
- Timing and duration of employment is short.
- A specific geographic area is selected.
- Complete destruction of enemy forces is not required to achieve a desired objective.
- Yield limitation is medium to very low. (See Glossary for definitions.)
- Collateral-damage constraints are stringent.
- Targets are military.
- Aircraft and/or missile delivery platforms are in the theater. (They are not launched from the US or from one theater to another, but from within the theater.)

### The Operational Level of War

At the operational level of war, joint and multinational forces within a theater of operations (TO) plan, conduct, and sustain campaigns and major operations to accomplish theater strategic objectives. The operational-level commander focuses nuclear-weapons planning largely on one or more of three general tasks:

1. Facilitating maneuver.
2. Isolating the battlefield.
3. Destroying critical enemy facilities or functions.

The operational level of war is the vital link between national- and theater-strategic aims and the tactical employment of forces on the battlefield. The focus at this level is on conducting joint operations. Joint operations include employing multiservice military forces to attain theater-strategic objectives in a theater of war.

Combatant commanders usually plan and execute campaigns. They have theater-strategic intents, concepts, and objectives. Service or subordinate joint commanders have operational intents, concepts, and objectives in support of the combatant commanders. The level of command varies with—

- The nature of warfare.

- The strategic objectives.
- The size and structure of the theater of war.
- The number of forces involved.

The intended purpose, not the level of command, determines whether the unit functions at the operational level. Armies normally design major ground operations of a subordinate campaign, while corps and divisions fight tactical battles and engagements. A corps commander might also be a joint force land component commander or the commander of a joint tactical force.

Commanders of unified commands conduct theater campaign planning with subordinate headquarters. The subordinate command and its staff consult with sister services throughout the planning process. In turn, tactical commanders help develop the initial concept of operations and subsequent campaign plans. Subordinate commanders prepare supporting plans to meet the requirements of the theater plan. Commanders at corps and above modify plans as necessary to attain operational objectives so long as they still achieve the theater's strategic intent. Commanders of joint and combined forces develop comprehensive plans which integrate aspects of each service commander's operational plans.

### Airspace Coordination

When a CINC requests nuclear-weapons release, he must consider how he will manage airspace, airspace priorities, communications instructions, and special joint airspace requirements. Since all components of the joint force use the airspace above surface areas, the CINC must issue airspace control measures to deconflict the space.

The CINC will appoint an airspace control authority, who is normally also the joint force air component commander. Use and control of airspace must be coordinated with the airspace control authority.

### Nuclear Targeting

#### Identifying Enemy Targets

This section supports the doctrine of counterforce targeting strategy as JP 3-12 describes. Army nuclear targeting utilizes the targeting methodology in

the decide, detect, deliver, and assess (D<sup>3</sup>A) process—

- To identify enemy high-value targets.
- To determine friendly high-payoff targets.
- To prioritize targets for attack by the most effective means.
- To nominate or deliver selected weapons.
- To assess the effects of attack against surface targets.

NOTE: The D<sup>3</sup>A process is discussed in more depth later in this chapter. See also FM 6-20-10.

The most likely enemy nuclear targets are—

- Nuclear, biological, and chemical capabilities.
- Troop concentrations.
- Command, control, communications, and intelligence facilities.
- Logistics considerations.
- Underground facilities containing HPTs.
- Targets which would severely impact the campaign plan.
- Air defense facilities.
- Weapons of mass destruction.
- Mobile land battle targets.

At operational and tactical levels of war, commanders use targeting methodology to identify and prioritize targets. The CINC gives first priority to operational targets. The corps translates operational guidance into specific tactical targeting priorities. The corps commander uses his priorities to nominate targets. The JFLCC nominates targets to the JTCB, if there is one. The corps commander must take into consideration the time it takes to process his nomination up the chain of command, over to the sister services and their targeting process, then to final execution. (Refer to Figures 3-3, 3-5, and 3-6.) He must also plan conventional operations as contingency operations.

### Targeting Considerations

Nuclear weapons are not equally suited for all battlefield requirements so there is no reason to employ them if they produce only marginal gains in

effectiveness over nonnuclear fires. Advantages of using nuclear weapons vary with—

- The weapon type, yield, and accuracy.
- The nature and disposition of the target.
- The terrain and weather.
- The operational or tactical objectives.

Commanders must also integrate nuclear-weapons use into conventional fires and maneuver.

A commander would normally nominate a weapon capable of a low air burst rather than one that has a surface burst. This would optimize basic nuclear effects and reduce militarily significant fallout.

Another consideration is the unpredictable time requirements for nomination of nuclear weapons. Advanced planning is absolutely critical. When commanders nominate targets, destruction of the targets should radically alter the situation to the user's advantage. Commanders must know the strengths and weaknesses of each course of action in order to nominate targets which present the highest payoff. Therefore, it is imperative that commanders conduct continuous planning. Using real-time intelligence assets in determining and updating targets is essential. Timing and accuracy are major factors in nuclear-weapons nomination success.

The requirement to deconflict duplicate targeting complicates targeting. Different forces or different echelons within the same force may have the same needs. Therefore, synchronizing attacks between echelons is absolutely necessary.

### Troop Safety

Targeting considerations must also include troop safety such as—

- Collateral-damage avoidance.
- Personnel safety.
- Preclusion damage avoidance.

Commanders must limit nuclear strikes near friendly forces and the civilian populace. However proximity can vary according to—

- The protection available for friendly units.

- The location of the civilian populace.
- The availability of weapons yield.
- The weapons systems used.
- The deconfliction with SOF, long-range surveillance units (LRSU), and other friendly locations across the FLOT.

Nuclear targets in support of maneuver units are normally deep, but early warning and protection measures are important for all units. Normally there is no requirement to warn units when the risk will not exceed negligible levels and when insufficient time exists to warn all personnel.

Obstacles created by nuclear weapons can inhibit movement of future operations. Principal obstacles are tree blowdown, fires, area contamination, and rubble in built-up areas. Commanders nominating nuclear weapons must consider how such obstacles will restrict maneuver. They must also consider the degrading effects of nuclear weapons on both friendly and enemy communications and fire control systems.

### **Decide, Detect, Deliver, and Assess (D<sup>3</sup>A) Targeting Methodology**

The D<sup>3</sup>A targeting methodology enables the commander and staff to take the initiative in selecting HPTs before they actually present themselves in the target array. Each function occurs both simultaneously and sequentially. Although not a separate function, target tracking is inherent throughout the targeting process. Target tracking must be planned simultaneously with the development of the intelligence collection plan (decide). It is executed during the targeting function of detect and supports both targeting functions of deliver and assess.

Decide, detect, deliver, and assess targeting methodology helps maximize the effectiveness of the limited number of nuclear weapons available. The decision to recommend attack of a target provides the focus and priorities for intelligence collection and fire planning. The commander orients the attack after analyzing—

- The intelligence estimate of the situation.
- The commander's mission analysis.
- Battlefield planning (which projects future operations).

Before setting target priorities, operations, intelligence, and fire support officers conduct target-value analyses (TVÁ). They consider the—

- Perceived importance of the target.
- Ease and accuracy of locating targets.
- Relative ease of destroying the targets (hardness and mobility).
- Probable length of time target destruction will disrupt a threat force.

The initial detection and tracking of designated threat units with intelligence sensors should not always be the attack trigger event. Tracking selected targets keeps them visible while the corps validates them in the nomination process.

The deliver step totally depends on sister services reacting to the needs of operational-level and corps commanders. For them to respond quickly, they must have as much lead time as possible. Therefore, commanders must consider timing and other events while war-gaming.

During the assessment phase, a battle damage assessment (BDA) gives the commander feedback on the effectiveness of the nuclear weapon. During the decide step, planners determine the requirement for battle damage assessment for specific high-pay-off targets and/or counterproliferation targets.

### **Defeat Criteria**

No single statement of damage criteria covers all situations. The appropriate nuclear appendix to the OPLAN includes defeat criteria for nuclear-weapons nomination. General guidelines include the following:

- At lower yields, initial radiation, not blast or thermal radiation, is the foremost defeat mechanism for mobile land battle targets.
- The targeting officer subdivides large targets into smaller targets to reduce the size of the targeted area.
- The minimum safe distance for friendly units should be one of negligible risk to unwarned, exposed soldiers.



## Collateral-Damage Prevention

The commander must always seek to avoid civilian casualties from nuclear weapons in the campaign area. The G5 determines civilian population centers and produces population overlays depicting their locations. The fire support element (FSE) uses preclusion overlays to minimize damage consistent with the commander's guidance. The USANCA NEAT uses these overlays during analysis.

The commander can reduce most collateral damage by—

- Recommending a weapon that fits within collateral-damage preclusion criteria.
- Using damage-preclusion criteria.
- Recommending a low air height of burst.
- Placing a DGZ away from the area to be protected.

NOTE: See JP 3-12.2 (SRD) for procedures to calculate collateral-damage avoidance.

## Options

An option is a discrete grouping of nuclear weapons and is the basic element for providing nuclear support to the Army component. It ensures political authorities retain control of nuclear-weapons employment.

An option has specific yields. It is based on the mission, enemy, terrain (and weather), troops, and time available (METT-T); collateral-damage guidance; and constraints.

NOTE: See JP 3-12 and 3-12.1 for more information.

Operational-level and corps commanders plan and recommend options for specific geographical areas, during short time periods, and for specific purposes. However, an option's area varies with the echelon of command and its objective. At the operational level of war, the area of employment may cover several corps. In a corps this may extend from the corps FLOT to the limit of the area of operations. The numbers and types of weapons in an option will vary depending on—

- The level of command that develops it.
- The mission.

- The enemy.
- The terrain.
- Nearby population characteristics.
- Desired target effects.

Nuclear-option planning begins with mission receipt and includes four phases:

1. Pre-wartime contingency planning that is based on the type of operation and constraints.
2. Wartime planning that supplements peacetime planning based on limiting requirements, terrain, and actual threat intelligence.
3. Refinements to wartime planning that meet changing situations and which update options based on the latest threat intelligence.
4. Refinements to approved options that are based on the situations just before target nomination.

Planners develop each option along with the campaign plan and transmit both to higher headquarters for approval. Commanders up the chain of command, starting with the corps, treat the option and the plan as a single entity.

To provide the control and flexibility the NCA requires and needs, commanders at strategic, operational, or tactical levels must impose a time frame on each option. The time frame must be of sufficient length to accommodate uncertainties in intelligence and friction in battlefield conditions. Specifying a time frame helps maximize a nuclear option's benefits.

Commanders must synchronize the necessary time frame with the campaign plan. The NCA might constrain the time frame for options at the operational or tactical levels based on changes in the strategic environment. As a result, the nomination time for an option starts about 96 hours before execution.

During both offensive and defensive operations, each command echelon provides to their subordinates more detailed nuclear planning guidance based on METT-T factors. Within the limits of this guidance, the operations officer and the fire support coordinator (FSCOORD) refine the planned option to support the scheme of maneuver. This is not a one-step decision, but a continuous, dynamic process of adapting plans to meet operational require-

ments, constraints, and option parameters to provide the best effect before target nomination.

Before refinement, the nominating commander must understand the intent of his next higher commander. The commander can recommend—

- Updating target information.
- Adjusting individual aiming points within the option area.
- Exchanging higher yield weapons for lower yield weapons.
- Identifying and prioritizing aiming points.
- Coordinating nonnuclear fires with nuclear fires.

The commander nominating the option has the flexibility of selecting aiming points in the option area. This maximizes the effectiveness of the option and helps attain operational objectives. However, the commander must always consider troop safety in final aiming-point refinement, using updated collateral-damage overlays with troop-safety contours and the nuclear-weapons template. Higher commands normally state collateral-damage preclusion criteria in generalized terms and gross numbers. The nominating commander may impose more restrictive employment constraints.

## BATTLEFIELD OPERATING SYSTEMS (BOS)

The basic BOS (intelligence, maneuver, fire support, mobility and survivability, combat service support, command and control, and air defense) are the same whether commanders employ nuclear weapons or not. There is no doctrinal transition period from conventional to nuclear warfare. However, commanders may have to make some changes in planning techniques and procedures to accomplish these functions on the nuclear battlefield.

### Intelligence

Intelligence operations are the organized efforts of a commander to gather and analyze information about the enemy's activities. Intelligence supports operations by—

- Providing early indications and warnings of a threat's intention to employ nuclear weapons.

- Conducting intelligence preparation of the battlefield (IPB) to facilitate the targeting process.
- Developing the situation by determining if a threat is nuclear-capable.
- Developing suitable nuclear targets
- Protecting the force by disrupting a threat's nuclear operations.
- Performing the battle damage assessment.

In nuclear operations reliable and rapid collection, assessment, evaluation, and dissemination of target information is critical to the nomination process. Intelligence collection—

- Identifies a threat's intent to employ nuclear weapons.
- Locates his nuclear-capable delivery systems.
- Identifies targets vulnerable to nuclear fires.

The intelligence officer uses electronic warfare support measures (ESM) to determine a threat's intentions and to discover lucrative nuclear targets for exploitation. Electronic warfare support measures include search, interception, identification, and location functions.

### Maneuver

Maneuver is movement relative to the enemy to put him at a disadvantage. Commanders maneuver forces to create conditions for tactical and operational success. Maneuver enhances the friendly force's ability to destroy the enemy or hinder his movement through the direct or indirect application of lethal power or the threat thereof. Conversely, maneuvering large forces invites attack. The commander must always consider this issue during operational planning.

Maneuver and firepower are inseparable and complementary elements. While one might be more important in one phase of an operation, both are characteristic of all operations. The commander combines them to maximize relative combat power. Nuclear weapons greatly enhance the flexibility of maneuver. They also have the potential to be the principal means of destroying a threat's will to fight. When a commander nominates nuclear weapons, maneuver exploits their

effects. The commander can also nominate nuclear weapons—

- To support his scheme of maneuver.
- To mass combat power rapidly without shifting maneuver forces.
- To delay, disrupt, or destroy a threat's forces in depth.

### **Fire Support**

Fire support is the integration and synchronization of fire and effects to delay, disrupt, or destroy enemy forces, combat functions, and facilities in pursuit of operational and tactical objectives. The flexibility of nuclear-weapons nomination makes it possible to rapidly shift the focus and concentration of combat power over wide areas.

Operational-level and corps commanders can nominate nuclear weapons—

- To support their scheme of maneuver.
- To mass effects rapidly without shifting maneuver forces.
- To attack a threat's forces in depth.

### **Mobility and Survivability**

Mobility operations preserve the friendly force's freedom of maneuver. Mobility missions include—

- Breaching enemy obstacles.
- Increasing battlefield circulation.
- Improving existing routes or building new ones.
- Providing bridge and raft supports for river crossings.
- Identifying routes around contaminated areas.

Nuclear weapons will cause extensive damage and may drastically alter the military aspect of terrain. Therefore, commanders must determine if using such weapons would create so many obstacles that units would spend more effort breaching them than would be worthwhile.

NOTE: See DA Pam 50-3 for a detailed discussion of nuclear-weapons effects on terrain.

Survivability operations protect friendly forces from the effects of enemy weapons systems. Hardening facilities and fortifying battle positions are

active survivability measures. Chapter 2 explains this in greater detail.

Corps and division commanders can anticipate higher losses throughout the battlefield when the enemy uses nuclear weapons. Mass casualties and few available replacements will require that the commander develop plans and procedures to efficiently reconstitute combat power. This, in turn, will impact reconstitution planning.

### **Combat Service Support (CSS)**

As the scale and complexity of Army operations increase, the importance of combat service support to their success increases as well. Combat service support to the nuclear battlefield includes providing support to sister services. Coordination is vital. Combat service support units operate at all levels of war. Chapter 6 explains this in greater detail.

### **Command and Control**

Command means visualizing the current and future states of friendly and enemy forces then formulating concepts of operations to accomplish the mission. Command occurs from wherever the commander is, whether at a command post (CP) or in a tank moving with the main effort.

Control monitors the status of organizational effectiveness and identifies deviations from set standards and corrects them. Commanders acquire and apply means to accomplish their intents. Ultimately, commanders provide a means to measure, report, and correct performance. The corps commander must be able to make the final decision on nominated target locations before passing the information to his higher headquarters.

Reliable communications are central both to battle command and to control. This is particularly true when nominating nuclear weapons. Being able to quickly pass orders is critical. Therefore, commanders must establish methods to ensure positive command and control (such as using EMP mitigating measures, alternative nets, communications, and so on).

### **Air Defense**

Air defense units are particularly susceptible to the effects of nuclear weapons detonations. Missiles

and their associated launchers are vulnerable to blast and thermal radiation. Radars, control vans, and missile electronics are vulnerable to EMP. Refer to Chapter 2 for survival mitigation techniques.

## RECONSTITUTION

The ASCC plans and conducts operational and tactical reconstitution operations. Timely reconstitution in terms of people, organizations, command structure, and matériel is essential to continuing the mission. Reconstitution is a total process. Its major elements are reorganization, assessment, and regeneration. Weapons system replacement operations facilitate the receipt of bore-sighted equipment and qualified crews to units undergoing reorganization or regeneration.

*Reorganization* is the action the commander takes to shift internal resources within a degraded unit to increase its combat effectiveness. It may include such measures as cross-leveling equipment and personnel, matching operational weapons systems with crews, or forming composite units. The latter involves joining two units reduced in number to form a single full-strength unit. Commanders should maintain as much squad, crew, or team integrity as possible under the circumstances to contribute to unit cohesion and to provide a base for rebuilding if regeneration is required.

*Assessment* measures a unit's capability to perform its mission.

*Regeneration* is incremental and involves the rebuilding of a unit through—

- Replacing personnel, equipment, and supplies on a large scale. (The commander can combine personnel, equipment, and supplies to return the degraded unit to the specified level of combat effectiveness.)
- Reestablishing or replacing essential command and control.
- Conducting mission-essential training for the newly rebuilt unit.

Commanders must consider individual RES during unit regeneration. Personnel with high dose

accumulation should not be assigned to units whose members have low doses. This helps battalions and companies retain equal radiation states.

NOTE: See also FM 100-9, FM 100-10, FM 12-6, FM 63-3, FM 100-7, and FM 100-16.

Regardless of measures taken to enhance force survivability, some close combat forces will suffer severe losses. The nuclear environment does not allow the luxury of long personnel and materiel pipelines and the withdrawal and rehabilitation of units. Therefore, at least initially, the commander accomplishes force reorganization, reconstitution, and restoration from residual assets.

## SUMMARY

The Army's role in planning nuclear operations is the heart of Army nuclear doctrine. Planners conduct the planning process of joint nuclear operations in a deliberate manner, but in a crisis they may undertake whatever actions are necessary.

The Army also participates in force-projection operations as part of a joint force. This may include multinational forces as well. The corps headquarters can also function as a joint task force headquarters. In this role the corps takes on additional responsibilities. The corps can use the guidance in this chapter when the CINC requires target nomination.

The Army at corps and above is supported by USANCA NEAT during the planning and execution cycle. The CINC is supported by STRATLAT from USSTRATCOM. Knowledge of their actions is important to Army planners for coordination and interface.

Planning nuclear operations begins with the commander's guidance and ends with nuclear targeting and collateral-damage preclusion. The mechanism for articulating the nominated targets is an option. Specific nuclear combat functions describe particular requirements in a nuclear environment.

Reconstitution and reorganization of decimated units in a nuclear environment is accomplished by shifting elements in order to increase effectiveness. Regeneration is the rebuilding of decimated units.

## Chapter 4

# COMMAND AND STAFF RESPONSIBILITIES AND PROCEDURES

### RESPONSIBILITIES

This chapter discusses the sequence of actions (and the personnel responsible for those actions) that the senior Army commander conducts after receiving controls and constraints to nominate nuclear targets. Because the division does not normally nominate nuclear targets, its warfighting tasks are normally force protection and NBC defense from nuclear-weapons effects.

Procedures and actions for theater nuclear-weapons nomination are part of the command and staff action process. The commander and his staff consider factors and events unique to nuclear operations during the process. The NEAT from USANCA assists the Army commander. If the corps is a joint force land component command or a joint task force, responsibilities expand to include joint considerations.

The senior Army commander's concern is the nuclear-nomination process and nuclear-force protection. The division commander's concern is how enemy use of nuclear weapons will affect the division's scheme of maneuver when executing the corps commander's intent and when protecting the force.

### THE DECISION-MAKING PROCESS

The decision-making process includes mission analysis; commander's guidance; COA development, analysis, and the decision; publishing the OPORD; and execution. The process is also used in organizing nuclear operations staff procedures.

NOTE: See Chapter 3 for a discussion of coordination and execution.

#### Mission Analysis

During mission analysis each staff agency maintains current day-to-day information necessary for preliminary nuclear-weapons considerations relat-

ing to its functional area. The following discussion lists staff elements and functions by event sequence.

The G2 staff's considerations include—

- Current or anticipated high-value targets, including ballistic and/or cruise missiles that have a variety of munitions (for example, weapons of mass destruction).
- Current threat antiballistic missile and/or anti-delivery systems.
- Weather data to facilitate weapons selection and fallout prediction and to evaluate effects on future operations.

The G3 staff's considerations include—

- Existing CONPLANS, OPLANS, OPORDs, and SOPs for nuclear nomination.
- The initial coordination between the FSCoord and the BCE for nuclear-weapons status.
- Constraints that higher headquarters imposes on the number and yields of nuclear weapons.

The G1 staff's considerations include—

- Plans for handling mass casualties in the event of the enemy's use of weapons of mass destruction.
- Coordinating with the medical brigade and or medical group for help with planning and handling contaminated patients. (See the FM 3-series manuals and FM 8-10-7 for handling biological and chemical casualties.)
- Battlefield nuclear warfare (BNW) implications on current personnel strengths.
- The current radiation exposure states (RES) of battalion-size units.

The G4 staff's considerations include resupply and reconstitution requirements based on enemy nuclear-weapons use.

The G5 staff's considerations include—

- Identifying population centers and preclusion data which would warrant preclusion from blast,

radiation, and thermal effects based on higher headquarters' constraints.

- Determining the current locations of civilians in the operational area.
- Conducting psychological operations (PSYOP) and providing information to civilian populations.
- Determining the status of noncombatants.

The FSCOORD staff's considerations include—

- Conducting nuclear planning.
- Nuclear-option planning criteria as stated from higher headquarters, plans, and SOPs.
- Integrating nuclear nomination plans with conventional operational plans and the scheme of maneuver.
- Integrating USANCA NEAT's analysis.
- Advising on the impact of US nuclear weapons on the enemy.

The NBC chemical center (NBCC) staffs considerations include—

- Identifying contaminated areas.
- Assisting in nuclear planning.
- Conducting nuclear vulnerability analyses.
- Maintaining the current assessment of threat capability to employ weapons of mass destruction.
- Developing a radiological monitoring and surveying plan.
- Predicting fallout hazards and how they might affect operations.
- Advising on the impact of enemy use of nuclear weapons on the civilian population.

The G6 staffs considerations include—

- Advising on how EMP will affect communications equipment.
- Advising on the availability and vulnerability of digital equipment.
- Advising on mitigation against EMP effects.
- Ensuring communications links are secure and operable for transmission of high-priority messages.

### Commander's Guidance

Once the commander receives or deduces his mission, he conducts mission analysis. He restates the mission and expresses his clear intent on how to conduct the operation to support the campaign plan. Once he has been directed to nominate nuclear targets, he will need supplemental command guidance from higher headquarters. He will then pass the following elements of command guidance to his staff for conducting planning:

- The desired results of nuclear-weapons nomination.
- The priority and types of targets to be nominated.
- Identification of tactical contingencies that might require nuclear-weapons nomination.
- The desired degree of damage to enemy forces.
- Collateral-damage criteria for civilian protection.
- Restrictions on fallout from surface bursts.
- Constraints from higher headquarters.
- Other necessary constraints, such as troop safety or preclusion of damage to equipment and aircraft.

The commander and staff must also consider troop safety at all times in terms of degrees of risk and vulnerability. They must consider the risks associated with using a lower category of protection for each situation and weigh these against the achievable payoff (for example, a status of "emergency risk to warned protected" instead of "negligible risk to unwarned exposed" personnel).

### Course of Action Development

Based on guidance for nuclear planning, each staff agency conducts its own estimate in support of the operation. The information the staff collects is then used in COA development. Each staff element checks its data for suitability, feasibility, acceptability, and distinguishability within its own area of expertise.

The G2 staff—

- Identifies potential enemy nuclear targets based on event templates and current intelligence.

- Determines an enemy's nuclear capabilities and his vulnerabilities to attack by any means.
- Evaluates friendly vulnerabilities to enemy nuclear-weapons use and how they would affect operational plans.

The G3 staff—

- Integrates nuclear and conventional weapons into a COA analysis.
- Modifies target-defeat criteria based on operational considerations.
- Identifies NBC defense considerations.
- Develops nuclear-nomination decision points for both offensive and defensive operations.
- Determines collateral-damage criteria.
- Determines requirements for unit replacements.

The G1 staff—

- Develops an estimate of casualties expected from an enemy nuclear-weapons attack.
- Estimates the impact of mass casualties on combat health support and mortuary operations. The medical brigade, medical group, and command surgeon's staff provides input to the G1 on the impact of mass casualties on combat health support.
- Determines the commander's guidance for radiation casualties to enter medical channels.
- Identifies personnel issues with respect to nuclear operations.

The G4 staff specifies COAs for logistics.

The G5 staff—

- Develops the civilian population center overlay.
- Develops the collateral-damage and preclusion-area overlays or lists.

The G6 staff—

- Develops an estimate of the situation for signal support.
- Establishes requirements for voice, data, and broadcast traffic.
- Provides the concept and visualizes signal support for the battlefield after the commander chooses a course of action.

The FSCOORD staff—

- Formulates nuclear options for each contingency the G3 identifies.
- Determines nuclear planning parameters.
- Receives preclusion data from the G5.
- Develops and refines nuclear analysis based on input from the USANCA NEAT and the corps targeting officer.

The targeting officer provides current operational information to the USANCA NEAT.

The NBCC staff—

- Prepares the NBC estimate.
- Provides expert information on nuclear effects, vulnerability analysis, and mitigation of enemy use.
- Coordinates the NBC warning and reporting system throughout the NBCC.
- Details passive measures to reduce friendly vulnerability.

At this time—

- Based on the information they exchange, the G1, G4, and G5 redefine their estimates.
- The G2 completes the intelligence estimate, including an analysis and listing of the enemy's current nuclear-weapons capabilities, and updates the target-collection plan.
- The G3 completes the operations estimate specifying the desired damage and determines how nuclear-weapons effects will impact courses of action.
- The FSCOORD completes his estimate and determines targets to be nominated (supported by a targeting officer and the USANCA NEAT) after considering—
  - The importance of the targets in priority.
  - The safety criteria for the weapons to be nominated.
  - The specific limiting requirements within the recommended course of action.

### Course of Action Analysis

The staff conducts a quick initial staff analysis to identify COAs that are infeasible or not supportable. After discarding these, the staff conducts a detailed COA analysis that consists of—

- War-gaming COAs.
- Comparing COAs to determine which will best accomplish the mission.
- Presenting a recommendation to the commander.

The G2 staff—

- Examines how nuclear weapons will influence the enemy.
- Searches for indications of an enemy's intent to use nuclear weapons.
- Determines an enemy's likely reaction to the Army's nomination of nuclear weapons.
- Determines damage-assessment alternatives.
- Analyzes any indication of an enemy's intent to use weapons of mass destruction against friendly operations.
- Analyzes an enemy's probable reaction to the use of nuclear weapons against him.
- Analyzes the terrain based on friendly or enemy use of nuclear weapons and on the weather and how it will affect nuclear-weapons employment or mitigation.
- Analyzes damage assessments after nuclear detonation.
- Prepares an assessment of the enemy's capability to employ other weapons of mass destruction.

The G3 staff—

- Reviews and analyzes nuclear implications for the mission.
- Integrates nuclear weapons into COAs.
- Examines friendly nuclear capabilities and vulnerabilities.
- Formulates troop-safety, OEG, and collateral-damage factors.
- Formulates defeat criteria.
- Determines nomination decision points.

- Compares troop-safety criteria with the OEGs of battalion task forces and other battalion-size units.
- Analyzes vulnerabilities to an enemy's nuclear attack based on mass versus dispersion of battalion-size units.
- Assesses the impact of nuclear-weapons employment on an enemy's COAs.
- Compares various conventional alternatives to the nuclear-nomination process.
- Compares the effectiveness of nuclear and non-nuclear weapons.
- Coordinates with other staff members to create the decision support template (DST).
- War-games COAs for nuclear operations.
- Advises the commander on operational aspects of reconstitution.

The G1 staff—

- Assesses the potential for mass casualties. (The medical brigade and/or medical group and the command surgeon's staff provides input to the G1 on the impact of mass casualties on combat health support.)
- Reviews law-of-land-warfare considerations and requirements.
- Provides personnel input to the G3's reconstitution plans.

The G4 staff—

- Reviews the logistic implications of battlefield nuclear warfare.
- Provides logistic input to the G3's reconstitution plans.
- Examines the effect of nuclear weapons on logistic operations for each course of action.
- Conducts operational analysis and risk assessment, determining ways to minimize loss of logistics personnel and equipment.

The G5 staff—

- Determines the effects of BNW on civil-military operations (CMO).
- Reviews civilian casualty and collateral-damage parameters.



- Prepares the preliminary collateral-damage overlay.
- Compares information with each of the operational COAs on the locations of civilians.

The G6 staff—

- Compares digital support required to support each course of action.
- War-games actions when digital support is lost because of EMP effects.

The FSCOORD staff—

- Examines nuclear-weapons effects of the mission.
- Examines the target analysis that the USANCA NEAT provides.
- Examines collateral-damage requirements.
- Examines nuclear operations and planning.
- Recommends target nominations to the commander.
- Recommends nuclear targets by military importance and priority.
- Specifies the impact of nuclear operations on fire support COAs.

The targeting officer assists the USANCA NEAT in target analysis.

The NBCC staff—

- Prepares fallout predictions required for nuclear nomination.
- Provides the G3 with technical data needed to develop vulnerability of friendly forces to fallout.
- Estimates predicted fallout effects on operations in respective areas of interest.
- Assists the G3 in force-protection planning.
- Evaluates friendly decontamination capabilities.

After the staffs briefing, the commander reviews their analyses, evaluates all estimates, and determines how nuclear-weapons use would affect the scheme of maneuver. This course of action comparison, which leads to a staff recommendation and the commander's decision, includes—

- The mission.

- The situation and the course of action.
- The commanders' estimate.
- The G2's and FSE's target-value analysis.
- The G3's analysis of nuclear-weapons effects.
- The commander's and staffs comparison of COAs.
- The decision.
- The statement of the commander's intent.

## THE COMMANDER'S DECISION

Based on the staff's recommendation, the commander decides if a situation warrants nuclear-weapons nomination to accomplish a mission that might otherwise be infeasible. He must also determine the adverse impact on the mission by nuclear weapons.

NOTE: See Chapter 5.

Considerations affecting the situation and the course of action include—

- The area of operations (terrain and weather effects).
- The enemy's situation (his vulnerability to US nuclear weapons and the assessment of his capability and intent to use nuclear weapons).
- Readiness. (The ability of sister services to rapidly deliver nuclear weapons and to maneuver combat power.)
- Vulnerability. (Friendly vulnerability to nuclear weapons is a function of time and space; the commander must consider the degree of risk he is willing to accept.)
- Relative combat power (comparison of friendly and enemy nuclear weapons and maneuver combat power).
- Courses of action (defined in terms of what, when, where, how, and why).
- Reconstitution assessment of units.

During the commander's estimate, the commander and staff war-game each COA against the selected enemy capability. The commander

war-games each COA from start to finish and rehearses the plan. The G3 and FSCoord update nuclear targets for nomination during this process. The commander and staff must be alert for likely times and areas where the enemy might use nuclear weapons.

During the war game, the commander and his staff continuously reassess the vulnerability of the force to enemy nuclear strikes. The planner looks at the target he presents through the eyes of an enemy target analyst to answer such questions as—

- Does my force present a target that the enemy will decide is worth expending a nuclear weapon to destroy?
- Does the enemy have time to locate, analyze, and attack my force?
- Will my force move at such a high rate of speed that an enemy cannot attack it?
- Will my force be so close to the enemy that he will have to violate his own doctrinal constraints in order to strike?
- What type of weapon with what yield will the enemy use to attack my force?
- Will a nuclear-capable enemy's use of nuclear weapons at this location restrict his maneuver?
- Will my nomination of nuclear weapons at this location restrict my maneuver?

The G2's and FSE's target-value analysis determines—

- The perceived criticality of the targets.
- The ease of locating the targets.
- The relative ease of destroying the targets.
- The relative length of time of disruption of forces that could be expected from destroying the target.

The G3's analysis of nuclear-weapons effects includes—

- The probable enemy reaction.
- Critical events and how to achieve success.
- Nuclear recommendation of decision points.
- The advantages and disadvantages of nuclear-weapons nomination.
- Troop-safety constraints.

The commander's and staffs comparison of COAs weighs the advantages and disadvantages that emerge during the analysis. They make realistic assessments of the risks of probable enemy reactions during each phase of the operation.

After comparing COAs, the commander determines which will best accomplish the mission. He announces his decision. The commander amplifies his statement of intent with respect to conducting operations. (It is a critical requirement that subordinates must operate within the intent of the senior commander.) The commander's statement of intent includes—

- The effects he desires from the nuclear weapons he nominates (such as halting the enemy) or his decision not to nominate nuclear weapons.
- Constraints placed on the senior Army commander by the operational-level commander. (The senior Army commander reviews the nuclear option to ensure it follows the campaign plan.)
- Nuclear-nomination decision points.

The commander must identify decision points as early as possible because it is imperative that the G3, G2, and FSCoord know where such decision points might occur. They must also know the turn-around time for the decision process. There are two examples of discussion points in the planning sequence. One is at the operational level when nuclear weapons would be required to ensure the success of the campaign plan. The second is at a time when the command lacks significant maneuver forces and conventional combat power to accomplish a mission.

The commander's statement of intent also includes—

- Collateral-damage avoidance requirements, if different from the SOP.
- Damage assessment, if different from the SOP.
- The number of weapons recommended to accomplish the mission.
- A statement of the desired level of troop-safety risk. If the risk is not the same as in the SOP, it must be so stated.

## PROCEDURES

### Plans (Orders) Preparation

Based on the commander's decision, each staff agency coordinates and writes its portion of the OPLAN or OPORD and submits it to the commander for his approval.

The G2 staff—

- Integrates enemy nuclear capabilities intelligence into the OPLAN.
- Identifies an enemy's BNW capability in the enemy situation intelligence annex of the OPLAN.
- Defines vulnerabilities to the enemy's nuclear capability.
- Defines enemy strengths against nuclear employment.
- Integrates nuclear operations requirements into the OPLAN.
- Defines the nuclear aspect of the mission and concept of operations.
- Specifies nuclear C<sup>2</sup> requirements.
- Defines nuclear troop safety.
- Develops plans for aerial radiation survey and monitoring assessments.

The G1 staff—

- Identifies procedures for handling BNW mass casualties.
- Identifies personnel replacement and unit reconstitution requirements and priorities under BNW conditions (assisted by the medical brigade and/or medical group and the command surgeon's staff).
- Identifies alternative administrative procedures in the event of automated data processing (ADP) capability loss.

The G4 staff—

- Integrates logistic considerations into the OPLAN.
- Provides logistic input to reconstitution plans.

The G5 staff—

- Publishes noncombatant demographic data and overlays.

- Specifies noncombatant casualty and collateral damage parameters.

- Identifies aspects of BNW to exploit by PSYOP.

The G6 staff—

- Provides the signal annex that integrates communications considerations into the OPLAN.
- Develops plans for positioning communications assets.

The FSCoord staff—

- Creates and publishes nuclear support plans with nuclear options.
- Identifies joint service nuclear planning coordination requirements.
- Develops plans to prevent collateral damage.
- Passes force-protection guidance to the divisions and to the analysts who determine WMD vulnerability.

The NBCC staff—

- Develops plans for monitoring fallout from friendly delivered nuclear weapons.
- Initiates planning to minimize effects.
- Advises on contaminated areas.
- Advises on decontamination.
- Passes STRIKWARN messages to the next lower echelon.
- Prepares fallout predictions required for nuclear nomination.

### Approval and Issuance of the OPLAN (OPORD)

The corps commander approves plans (orders) and the nuclear option for each contingency in the plan. The option is then transmitted through the operational-level commander to the CINC for inclusion in his OPLAN. The CINC passes the option to the NCA for final approval and execution. The G3 is responsible for issuing the approved OPLAN (OPORD) to subordinate units.

## SUPERVISION

Both the commander and his staff supervise the execution of the nuclear operation. To ensure that options follow the intent of the nuclear portion of the campaign plan, command supervision is continuous. Command supervision also—

- Continuously assesses the situation and updates the mission analysis and the concept of operations with respect to nuclear operations.
- Assimilates nuclear nominations information and instructions from higher headquarters.
- Updates nuclear guidance to commanders and staffs.
- Facilitates nuclear-planning coordination.

Staff supervision occurs at each staff level and each staff member supervises nuclear operations within his own area. The G2 maintains the status of an enemy's nuclear systems and updates target nominations for potential inclusion in the nuclear option. He coordinates and tasks intelligence-collection assets to provide BDAs. His staff—

- Coordinates nuclear-specific intelligence-collection efforts.
- Develops and publishes intelligence summaries on the enemy's nuclear capabilities.
- Provides detailed intelligence on nuclear target parameters.
- Updates vulnerability assessments.
- Maintains nuclear data on intelligence overlays.

The G3 supervises the dissemination of strike warnings by NBC elements. His staff—

- Coordinates nuclear planning.
- Assimilates and integrates all BNW data into information displays, including the radiation status, the effects of nuclear weapons on signal operations, mass casualty information, reconstitution efforts, and NBC reporting and dissemination data.
- Coordinates BNW situation updates.
- Synchronizes nuclear command and control.
- Monitors an enemy's BNW activity.

- Monitors the effects of nuclear weapons on the terrain and coordinates with engineers.

The G1 maintains casualty statuses, replacements, OEG, and RES. His staff—

- Maintains BNW-related personnel operations data on information displays.
- Monitors the casualty situation and coordinates BNW-related combat health support and mortuary operations.

The G4 maintains BNW-related logistic data on information displays.

The G5 maintains up-to-date information on civilian locations and status. His staff—

- Maintains data on noncombatant information displays.
- Updates and coordinates population density information with respect to collateral-damage parameters.
- The FSCOORD updates targets. His staff—
- Coordinates options planning efforts.
- Coordinates with the BCE and NALE to receive information concerning the nuclear weapons to be delivered.
- Coordinates with the G2 to recommend poststrike target analyses.

The NBCC staff—

- Maintains records concerning the RES of units and coordinates with the G1.
- Receives, collates, evaluates, prepares, and distributes NBC reports.
- Reviews the poststrike analysis damage assessment.

The signal officer advises the commander on protective measures taken against EMP effects.

The surgeon advises the commander on the medical effects of the nuclear weapons environment. He recommends initial nuclear triage criteria. The surgeon provides information to the G1 on CHS personnel requirements to maintain the support mission.

## **MISSION ACCOMPLISHMENT AND FEEDBACK**

Mission accomplishment is the successful employment by sister services of nuclear weapons in support of Army operations. It is based on command and staff actions leading to the nomination of targets.

The commander and staff action process is continuous. Based on current operations and the commander's intent, the commander and staff refine the nuclear-weapons nomination process to ensure its optimal use. The commander's primary means of monitoring the battle is the feedback he receives from forces in contact with the enemy and from intelligence-gathering capabilities.

The command and staff action sequence ensures that the commander has the necessary up-to-date information to make sound judgments on nuclear-weapons operations. The key is the feedback received from the BCE for nominated targets and the NBC defense reports received from adjacent and subordinate units.

### **SUMMARY**

The Army commander must be prepared to integrate nuclear nominations into his planning process

at any time. Both the commander and the staff have responsibilities to accomplish and procedures to follow. Their responsibilities range from target nomination to force protection. The framework the commander and staff use to accomplish the mission is the decision-making process. Each staff officer has certain considerations in the initial mission analysis.

Once the commander receives or deduces his mission he conducts his mission analysis and issues his command guidance. Based on the guidance for nuclear planning, each staff agency conducts its own estimate and participates in COA development. After developing and analyzing each COA, the staff identifies which to recommend to the commander. Based on the staff's recommendation, the commander decides if the situation warrants nuclear-weapons nomination. He then approves the nuclear option to be submitted to the CINC.

These procedures result in the preparation of plans and orders. The commander approves the OPLAN (OPORD) and the G3 issues the OPLAN (OPORD) to subordinates.

## Chapter 5

# NUCLEAR SUPPORT TO COMBAT OPERATIONS

### TENETS OF ARMY OPERATIONS

The Army's success depends on its ability to operate within five fundamental tenets: initiative, agility, depth, synchronization, and versatility. (See FM 100-5). In nuclear operations these tenets take on added meaning. Isolation of units, mass casualties, and loss of C<sup>2</sup> capabilities will necessitate semiindependent operations and decentralized control. Therefore, unit commanders must fully understand the higher commander's intent.

Continuing the mission under adverse circumstances requires initiative. When units can no longer adequately perform their traditional roles, leaders must have agility; that is, they must have the ability to quickly adapt to a new situation in order to accomplish combat tasks without changing task organization. Adding depth to a battlefield gives all forces the space in which to disperse. Depth enables forces to take actions to minimize vulnerability to nuclear attack and nuclear effects. Commanders at corps and above synchronize nuclear operations by deconflicting targets, maneuver forces, and nuclear weapons to prevent collateral damage (fratricide) and to enable commanders to determine, through a trade-off analysis, whether or not to nominate nuclear targets. Loss of digital communications links because of EMP damage places stress on CSS units and will affect their ability to provide adequate support functions. Therefore, CSS units must retain as much versatility as possible to continue the mission.

### AREA OF OPERATIONS (AO)

Three closely related sets of activities—deep, close, and rear operations—are characteristic of an area of operations. Commanders conduct operations in AOs simultaneously throughout the depth of the battlefield and mass both effects and forces when and where necessary to accomplish the mission.

United States operations must appear to the enemy to be one continuous operation against him.

Because targets and operational or tactical considerations or both vary with each operation, commanders must consider nuclear-weapons operations throughout the depth of the battlefield.

Forces in immediate contact with the enemy, in the offense or defense, are conducting close operations. In corps close operations, as with other operations, the theater CINC controls nuclear weapons. Close coordination by the corps commander, with the CINC, is essential to ensure successful execution. If required, the corps commander recommends a yield that fits within troop-safety criteria and nominates the target with the highest payoff.

NOTE: See Chapter 3. (Although nuclear-weapons use in close operations is not the norm, it cannot be totally ruled out.)

Commanders direct deep operations at all levels with fires and maneuver against enemy forces and functions beyond close operations. Deep operations affect the enemy through either attack or threat of attack. They expand the battlefield in space and time to the full extent of friendly capabilities. Effective deep operations further overall mission success and enhance force protection.

In a nuclear environment, a corps commander nominates targets to be struck with nuclear weapons in support of corps deep operations according to campaign plans. Doing so—

- Creates a window for future offensive action.
- Destroys, slows, or reduces reinforcing forces.
- Creates the time and space for maneuver against attacking echelons.
- Destroys high-payoff targets.
- Forces dispersal of enemy units.
- Creates obstacles which canalize, delay, and disrupt enemy forces.
- Destroys enemy staging areas.

A variety of systems deliver nuclear strikes in support of deep operations. Corps- and operational-level commanders integrate these nuclear strikes with other deep attacks (maneuver, fires, or both).

The importance of near-real time target acquisition in deep operations dominates tire planning. It calls for speed from target acquisition to target engagement.

Rear operations help provide freedom of action and continuity of operations, logistics, and battle command. Their primary purposes are to sustain the current close, as well as deep, fights and to position the force for future operations. Therefore, commanders operating in a nuclear environment must make every effort to reduce the effects of an enemy's use of nuclear weapons by implementing actions to ensure dispersal, survivability, and force protection.

NOTE: See Chapter 2 for discussion of rear operations mitigation techniques.

### CHARACTERISTICS OF OFFENSIVE OPERATIONS

The main feature of an offensive battle is outflanking or bypassing the defender; that is, taking the initiative. Surprise, concentration, tempo, and audacity characterize offensive operations and are components of initiative. While strategic, operational, or tactical considerations may require defense, the defeat of an enemy force at any level may require shifting to the offense.

NOTE: See Figure 5-1 to determine the effects of nuclear weapons on the four characteristics of the offense.

The offense is the decisive form of war—the commander's ultimate means of imposing his will on the enemy. Nuclear weapons can help the commander achieve his aim and can greatly enhance offensive operations. They help achieve surprise, create confusion, and enable a commander to execute his attack vigorously while minimizing risks elsewhere. Operational-level and corps commanders may nominate nuclear weapons to seize the initiative, maintain the momentum, attack strengths, and destroy threats. Maneuver forces can then exploit the shock the nuclear attack causes. However, a nuclear environment increases the risks to attacking forces as well, and requires enhanced security and survivability projections.

The lowest level of offensive theater nuclear nomination occurs at the corps level. Targets of

Characteristics	Effects
Surprise	<ul style="list-style-type: none"> <li>• A large amount of fire power with minimal warning.</li> <li>• Confusion and shock.</li> </ul>
Concentration	<ul style="list-style-type: none"> <li>• Massing nuclear effects without massing troops.</li> <li>• Protecting forces by not concentrating units.</li> </ul>
Tempo	<ul style="list-style-type: none"> <li>• Increasing the tempo of attack.</li> <li>• Decreasing our tempo because of an enemy attack.</li> </ul>
Audacity	<ul style="list-style-type: none"> <li>• Putting the enemy on the defense psychologically and physically.</li> </ul>

Figure 5-1. Effects of nuclear weapons on the four characteristics of the offense

highest priority normally are those which are most likely to affect the campaign's outcome. Nuclear weapons quickly break down enemy resistance and help the attacking force achieve maximum penetration.

NOTE: See FM 100-15.

In the offense, the corps commander can nominate nuclear targets—

- To create opportunities for deep attacks.
- To weight the main effort.
- To destroy or neutralize supporting forces.
- To sustain the fight.
- To protect exposed flanks.

### Forms of Tactical Offense

The four general forms of tactical offense are movement to contact, attack, exploitation, and pursuit. Different forms of attack (simultaneously occurring throughout the operational area in closely aligned phases that shift back and forth) take new forms and offer increasing options for development. For example, as part of an offensive campaign, the corps might be given a mission which could require integrating theater nuclear fires with maneuver to achieve success. When the corps commander rec-

Forms	Probability of Nomination
Movement to contact	• Very low probability of initial use.
Attack	
—Hasty	<ul style="list-style-type: none"> <li>• Low probability in close operations.</li> <li>• High probability in deep operations.</li> </ul>
—Deliberate	<ul style="list-style-type: none"> <li>• Low probability in close operations.</li> <li>• High probability in deep operations.</li> <li>• Higher probability of destroying and/or disrupting enemy nuclear delivery units, chemical, and/or biological facilities, C<sup>2</sup>, logistics, and armored formations.</li> </ul>
Exploitation	• High probability in deep operations to block withdrawal routes or avenues of approach for reserves.
Pursuit	<ul style="list-style-type: none"> <li>• High probability of blocking routes of retreat.</li> <li>• Low probability of nominating targets by the corps.</li> </ul>

**Figure 5-2. Probability of nomination of nuclear weapons in various forms of tactical offense**

Form	Effect
Frontal attack	• Reduces the need for nuclear weapons when attacking across the entire front.
Penetration	• Enhances penetration when using low-yield nuclear weapons.
Envelopment	• Fixes the defender in place while maneuver units envelop his flanks or rear.
Turning movement	• Protects maneuver forces and attacks the enemy rear by using nuclear weapons as deep fires.
Infiltration	• Not applicable to this form of maneuver.

**Figure 5-3. Nuclear-weapons effects on forms of maneuver**

In a nuclear environment, as in conventional combat, the commander can achieve advantages in maneuver only through continuous planning and swift execution. The considerations of MSD, CDD, and crossing NIGA-contaminated areas dictate the placement of the DGZ. Figure 5-3 depicts various nuclear-weapons effects on the forms of maneuver.

ommends nuclear weapons to support the offense, he must consider—

- Nominating the highest payoff targets.
- The minimum safe distance for troop safety.
- The least separation distance for key man-made features.
- The collateral-damage distance for the protection of civilians.

The effects of nuclear weapons on forms of tactical offense affect each differently (Figure 5-2).

### Forms of Maneuver

The forms of maneuver are frontal attack, penetration, envelopment, infiltration, and turning movement. Commanders use these to orient on the enemy, not the terrain. The commander's concept of operations details how he will use fires to support whatever form of maneuver he selects.

## PLANNING THE OFFENSE

Planning for nuclear-weapons use in support of corps operations is continuous and congruent with all other planning; it does not depend on the quantity of nuclear weapons nominated. The planning considerations are appropriate to offensive operations. The commander and his staff must consider METT-T factors when nominating nuclear targets.

### Mission

Offensive operations normally allow subordinate commanders the greatest possible freedom. They focus on their mission and the commander's intent and make appropriate preparations for anticipated actions, including likely developments and opportunities for nuclear-weapons use. However, when nominating nuclear weapons, the commander assumes greater control over subordinate commanders to ensure adequate coordination.



## Enemy

Anticipating and planning against the effects of enemy nuclear-weapons use against friendly forces is critical to campaign design. Commanders must ask, "Does the enemy have nuclear capability?" If the answer is no, the question is moot. If the answer is yes, commanders must address issues such as dispersion, type, yield, delivery means, availability of weapons, doctrine, tactics, and the likelihood of use.

## Troops

The number and type of troops available could greatly affect the tactical plan. Nuclear weapons can rapidly and decisively enhance combat power. Smaller forces possessing nuclear weapons can accomplish the mission of larger forces not possessing nuclear weapons. The unit's RES determines its fitness for duty. The lower the RES, the healthier the soldiers.

NOTE: See FM 3-3-1.

## Terrain and Weather

Terrain and weather can affect nuclear-weapons operations and influence offensive maneuver. For example, tree blowdown in a heavily forested area would obstruct the forward movement of friendly forces.

Normally, tactical fallout will not be significant in a low air burst. However, weather conditions could cause rainout in the area of operations. Therefore, if rain or snow falls through a nuclear cloud, significant tactical fallout may occur. Rain and fog can also lessen the blast wave as it travels through dense air.

## Time Available

Offensive actions become harder to conduct when the enemy has had time to organize his defense. The friendly commander can nominate nuclear weapons to effect surprise, prolong confusion, and sustain disorganization. Conversely, the nomination process can erode friendly units' available time because of the necessity of having to relay information and requests up through the chain of command and back down again.

## CONDUCTING OFFENSIVE OPERATIONS

The commander plans and coordinates force movement in detail to avoid confusion and delay and to gain surprise. He concentrates his forces quickly, making maximum use of cover and concealment, signal security, and deception while avoiding or masking actions that would alert the enemy to the coming attack. He then conducts the attack rapidly and violently with concentrated firepower to disrupt enemy positions and hit deep in the enemy rear. Nuclear weapons can enhance and support such plans by providing—

- Destructive firepower. Nuclear weapons, even when limited, can help friendly forces cause great destruction of enemy positions with a minimum concentration of forces.
- Surprise. Because delivery of nuclear fires requires little visible unit preparation, surprise can be complete. However, OPSEC within the stockpile-to-target sequence is essential. Forces must avoid a great display of preparation before nuclear strikes to prevent the loss of surprise.
- Shock. Nuclear-weapons use disorganizes, demoralizes, and freezes enemy forces in place. However, these effects will only be temporary; exploitation must be immediate.
- Flexibility. As maneuver forces develop the situation, the commander can nominate nuclear weapons to develop a major operation. He might also substitute nuclear weapons for maneuver forces, allowing a smaller force to succeed in its attack against a stronger force.
- Obstacles. A nuclear weapon can alter terrain to create obstacles such as fallen trees, fires, craters, rubble, and radiation. This nearly instant creation of massive obstacles will allow a smaller force to succeed where a larger force might ordinarily be required. Creation of obstacles slows and canalizes counterattacks and denies terrain to the threat. But, like shock and surprise, obstacles are temporary. Conversely, obstacles can impede forward maneuver if the commander has not considered least-separation distances.

Nuclear weapons can provide the commander with a unique advantage. However, he equally

realizes that the advantages of surprise and shock are fleeting and only initially effective.

NOTE: The trade-off matrix in Figure 5-4, page 5-6, is a decision-making tool to help commanders determine whether or not to nominate nuclear weapons in the offense.

## CHARACTERISTICS OF DEFENSIVE OPERATIONS

Nuclear weapons are significant force multipliers. Their primary roles are to significantly defeat enemy forces and help friendly forces seize the initiative and transition to offensive operations, as previously discussed. The most effective use of nuclear weapons in the defense is to destroy the enemy's synchronization by—

- Breaking the tempo of his operation.
- Preventing him from concentrating his strength against key portions of the defense.
- Separating his forces.
- Attacking and neutralizing his artillery.
- Interdicting routes and disrupting or destroying critical deep facilities.
- Interrupting his fire support, logistic support, or  $C^2$ .

The defender can nominate nuclear weapons to enhance combat power and to reduce his risks in sectors which require economy of force operations. In addition, the threat of or actual use of nuclear weapons puts amassed enemy attacking force at risk and presents him with a dilemma. For example, the purpose of corps and JFLCC-nominated nuclear-weapons use would be to disrupt an enemy's concentration and flexibility. (Whether nuclear weapons are nominated or not, the possibility of their use will significantly influence how the enemy operates.) As enemy units advance toward the FLOT, they become committed to specific attack avenues, leaving fewer maneuver alternatives. The threat of nuclear-weapons use can force an aggressor to stay dispersed, inviting defeat in detail (that is, units can engage these smaller individual units by conventional means nearer the FLOT). When used in this way, threatening to use nuclear weapons becomes a deterrent.

Commanders must consider the enemy's potential nuclear-weapons use and protect their forces accordingly. The possible use of US nuclear weapons can also strongly influence a commander's alternate plans and help strengthen the usefulness of reserve forces. The senior Army commander can nominate nuclear targets without shifting maneuver forces. Since he retains a reserve of forces to allow for flexibility in responding to an attack, using nuclear weapons in support of or in lieu of a reserve provides additional combat power to enhance contingency plans.

Time is the basic ingredient of a successful defense. The corps commander can integrate nuclear targets into the defense—

- To destroy assault forces and echelons before they penetrate the main battle area (MBA).
- To blunt or stop a penetration.
- To destroy forces in a penetration.
- To disrupt enemy  $C^2$ .
- To destroy or disrupt enemy logistic support formations.
- To protect forces during counterattacks
- To create opportunities for offensive actions.

The corps' defensive pattern depends on METT-T. There are two defense patterns—mobile defense and area defense. Regardless of which defense a commander chooses, he uses nuclear-option methodology to nominate nuclear targets.

### Mobile Defense

Mobile defense is the defense of an area or position in which maneuver is used with organization of fires and utilization of terrain to seize the initiative from the enemy. That is, it orients on the enemy (either his defeat or his destruction) by employing a combination of fire and maneuver, offense, defense, and delay tactics. Characteristics of mobile defense are that it—

- Orients on the enemy's defeat or destruction.
- Requires allocation of the minimum force to the defense.
- Requires maximum combat power to the mobile striking force (MSF).

- Strikes at the decisive moment.
- Occurs simultaneously throughout the depth of the battlefield.
- Uses lethal and nonlethal systems.
- Requires greater mobility than the enemy's.
- Requires considerable depth of terrain.
- Trades terrain for maximum effect in order to overextend the enemy that the striking force is to attack.
- Sets up large-scale counterattacks.

In a mobile defense, timing the execution of nuclear weapons by EAC and the execution of the striking force is critical. Nuclear weapons can significantly offset the size of the striking force if nuclear weapons are employed on the enemy just before the mobile striking force crosses the line of departure (LD). Specific C<sup>2</sup> techniques (such as graphically depicting the minimum-safe distance (MSD), the least-separation distance (LSD), and the collateral-damage distance (CDD) on the operations overlay) can deconflict planned movements of

the striking force and on the location of nuclear DGZs. In addition, the striking force may have to cross areas contaminated by fallout and initial radiation. (See FM 3-3-1.) The commander uses the trade-off matrix in Figure 5-4 to recommend the final delivery time.

NOTE: The trade-off matrix is a decision-making tool to help commanders determine GO or NO-GO when nominating targets in either mobile or area defense.

### Area Defense

Commanders conduct area defense to deny the enemy access to designated terrain or facilities for a specified time. Commanders, seeking to destroy enemy forces with interlocking fires, organize an area defense around a static framework that defensive positions (forward and/or in depth) provide. In some cases an area defense can be part of a larger mobile defense. Commanders employ local counterattacks against enemy units penetrating between defensive positions.

DGZ ____						
Basic Effects	Distances					= Results
	MSD	LSD	CDD	Air Movement Distance (AMD) GO/NO-GO (note)	Ground Movement Distance (GMD)	
Blast	_____	_____	_____	_____	_____	_____
Thermal radiation	_____	_____	_____	_____	_____	_____
Initial radiation	_____	_____	_____	_____	_____	_____
Residual radiation	_____	_____	_____	_____	_____	_____
EMP	_____	_____	_____	_____	_____	_____
Flash blindness	_____	_____	_____	_____	_____	_____
Resolution:		MSD—Make troops safer or move DGZ.			Decision	_____
		LSD—Move DGZ.				_____
		CDD—Make civilian safer or move DGZ.				_____
		AMD—Ground aircraft.				_____
		GMD—Change ground plan or use mitigation techniques				_____

NOTE: Place a GO/NO-GO in each blank. The commander must resolve all NO-GOs or the decision is a NO-GO.

Figure 5-4. The trade-off matrix

The depth of the defense varies according to the situation. Commanders position their forces on suitable terrain with specific orientation and direction of fire or in sectors. Positioning of nuclear targets allows the commander to deploy his forces in greater depth and compels the enemy to retard mass to achieve a penetration. After an enemy attack, defending forces can use mobility to exploit the effects of nuclear weapons on the enemy to seize the initiative and transition to the defense.

## PLANNING THE DEFENSE

Planning the defense begins when commanders receive a mission or perceive a requirement to defend. The results of the defense should satisfy the intent of the next two higher commanders and set the terms for future operations. The planning process begins while the target is still deep.

Commanders may need to modify original plans as the situation changes. Therefore, tactical formations must be able to modify their direction of movement or reorient defenses during operations.

The defense, no less than the offense, should achieve surprise. Commanders must consider METT-T factors when conducting their estimates of how to meet mission requirements.

### Mission

The mission is the first consideration in planning the defense. Is the mission an area or a mobile defense? If it is an area defense, nuclear weapons can help attrit and defeat the enemy's main effort. If it is a mobile defense, nuclear weapons can enhance the striking force's combat power.

The commander must make his intent clear as to the type of defense he will conduct and for the nuclear targets he plans to nominate. He must make his intent known as early as possible in order to integrate nuclear nominations into either defense. Nuclear-weapons use would stop the momentum of the attacker or shock and confuse him, making him susceptible to an attack by the reserve.

NOTE: See also Chapter 4.

### Enemy

The commander must determine if the enemy does or does not have nuclear capability. Because of the proliferation of nuclear weapons, this determination becomes increasingly critical to all commanders. When planning the defense, the commander analyzes the enemy's doctrine, equipment, recent or past tendencies, intent, and probable COAs. From this information he determines critical points in time and space for enemy and friendly vulnerabilities during the battle.

The foundation of a defensive plan is locating, containing, and defeating the enemy's main and supporting efforts. In particular, commanders must anticipate the enemy's use of indirect approaches and his ability to project combat power into the rear area by long-range fires, infiltration, air mobility, unconventional warfare, and WMD, especially nuclear weapons. Based on this anticipation, the force can employ mitigation techniques to enhance survivability.

### Troops

When assigning missions during planning, commanders should consider their forces' composition, the level of teamwork, the state of training, and their leaders' experience. The mobility, protection, morale, and training of troops determine to some extent how they will perform.

On the nuclear battlefield, corps and lower commanders must also consider subordinate units' RES levels when determining which units will be available for defense operations. Commanders must also consider troop-safety levels for defending units and troop-safety criteria for forces left in place.

### Terrain and Weather

The defender must decide where he can best stop the enemy, then plan accordingly. Studying the terrain the enemy must traverse gives valuable information and may decisively influence the positioning of defense forces. The defending force must exploit any aspect of terrain that would impair enemy momentum or make it difficult for him to achieve mass or to conduct maneuver.

Defenders can use the effects of nuclear weapons to take advantage of the terrain-tree blowdown, rubble, and fires. Such obstacles, when combined

with poor weather, can isolate the battlefield or slow or canalize enemy movement or protect friendly positions and maneuver.

Terrain effects can also complicate exploitation of a counterattack by reserve forces. The defender can modify terrain to provide protection from nuclear-weapons effects to his advantage. For example, a fortifying rear-slope position of company- or platoon-size units can mitigate initial nuclear-weapons effects.

Weather and visibility affect how a defender organizes his forces on the terrain. Commanders must anticipate and plan for the impact of adverse weather or limited visibility on weapons systems and optical devices. However, a defensive plan that succeeds in clear conditions may be less effective in periods of bad weather. Contingencies to the basic plan should address necessary modifications to the defense during periods of reduced visibility.

NOTE: See also Chapter 2.

### Time Available

The amount of time to allot for preparation is crucial. The defense is far more effective when time is available to conduct necessary planning. Small units train to defend with minimal preparation; however, strong defenses take time to organize and prepare. For example, the CINC and the operational-level commander must provide enough time to the corps commander for proper preparation. Tactical commanders must have enough time to prepare defensive plans. Corps commanders must have time to conduct the decision-making process to nominate targets.

Lack of time may compel commanders to maintain a larger than normal reserve force or to accept greater risks than usual. They must avoid this. They and their battle staffs should take advantage of all available time in preparing the defense.

## CONDUCTING DEFENSIVE OPERATIONS

Commanders should use all available combat power in a unified and synchronized plan for conducting defensive operations. The plan should also include nuclear planning considerations.

The corps commander normally nominates nuclear targets in deep-operations areas and as exceptions in close operations. The results of rear operations must ensure the corps' freedom of action. The corps reserve operates in both area and mobile defenses.

### Deep Operations

Deep operations—

- Can disrupt the enemy's preparation and movement.
- Destroy high-payoff targets.
- Inhibit or deny vital enemy operating systems (C<sup>2</sup>, logistics, air defense).
- Create windows of opportunity for future maneuver operations.

The commander can nominate nuclear targets to achieve these ends, concentrating on destroying, delaying, and disrupting high-payoff targets. Massed units, headquarters, and logistics areas are lucrative enemy targets. Corps commanders may include transportation networks and LOCs as high-payoff targets because their destruction would slow the forward movement of armored forces.

The corps fights the deep operation while it monitors and supports the corps' close operation. The division's deep and close operations constitute the corps' close operation. The deep operation isolates the battlefield and allows the corps to deal with a larger force than if nuclear weapons were not used.

### Close Operations

The corps commander positions forces in the MBA to control or repel penetration. The most demanding missions will be against enemy units close to US ground forces because those missions require effective strikes against mobile targets without causing nuclear-induced friendly casualties. The ability to deliver nuclear weapons close to the FLOT contributes to—

- The deterrence of nuclear strikes against US and allied ground forces because of the assured capabilities to answer in kind.

- Creating a nuclear shield for US and/or allied theater buildup.
- A hedge against conventional failure.

Commanders must anticipate the need to nominate nuclear weapons no less than 96 hours away from the delivery time. The overriding factor will be troop safety and preclusion of collateral damage. Therefore, nuclear weapons delivered in the close battle, by necessity, will be in the lower yield spectrum. Weapons with low circular-error probabilities (CEPs) ensure higher accuracy.

### Rear Operations

The corps commander must plan rear operations to retain freedom of action and to sustain the force. Unit and individual nuclear mitigation techniques help maintain this freedom of action.

NOTE: See FM 100-15 for more information on rear operations.

### Reserve Operations

Nuclear weapons can greatly enhance the flexibility of reserve units for both mobile and area defenses. The commander can use the reserves to—

- Exploit vulnerabilities to counterattack.
- Create opportunities for a counterattack.
- Destroy isolated threat forces.
- Prevent enemy counterattacks against his flanks.

At the corps level and above, small counterattacking forces supported by nuclear weapons can achieve the results of a much larger conventional force. This leads to a transition to conduct offensive operations.

## SUMMARY

The tenets of Army operations, combined with the activities in the area of operations, express where nuclear support applies to combat operations in both the offense and the defense. The nomination of nuclear weapons enhances the characteristics of offensive weapons. Weapons effects influence the various characteristics of the offense. In the forms of tactical offense, the probability of the nomination of nuclear weapons ranges from very low to high. The discussion also includes nuclear-weapons effects on forms of maneuver. Such effects range from fixing the defender during an envelopment to having little to no applicability during infiltration.

Nuclear characteristics of defensive operations focus on target nomination against attacking enemy forces and compare application of nuclear weapons in both the mobile and the area defense. Planning for either defense must include consideration of METT-T factors. Planners can use a trade-off matrix to determine the feasibility of nominating nuclear targets when compared to the basic effects such weapons emit. This process leads to how the force will conduct defensive operations. This chapter discusses them in terms of deep, close, and rear as well as reserve operations.

The threat tying the defense discussion together is the nomination of nuclear targets. The objective of defensive operations is to defend only until the defending force has gained sufficient strength before it attacks.

This chapter also discusses planning for offensive operations in terms of METT-T factors. Finally, the trade-off matrix is used to determine the feasibility of conducting offensive operations.

## Chapter 6

# COMBAT SERVICE SUPPORT IN A NUCLEAR ENVIRONMENT

### THE COMBAT SERVICE SUPPORT PROCESS

Combat service support is the essential capabilities, functions, activities, and tasks necessary to sustain all elements of operating forces in theater at all levels of war. It includes the functional areas of supply, transportation, maintenance, combat health support, personnel, support, and field services.

In a nuclear environment large CSS facilities (less medical facilities) and activities are prime targets. Therefore, CSS commanders must integrate protective measures and procedures into daily operations to ensure CSS functions will continue. To maintain combat capability, commanders must sustain their forces with self-sufficient and well-trained CSS units.

With the dramatic changes nuclear warfare will cause, the CSS process will become more difficult to execute and even more critical to mission accomplishment. In a nuclear environment—

- Combat service support techniques and procedures will require changes.
- The depth of the operational area will increase.
- The CSS system will become more widely dispersed, forcing support units farther away from supported units.
- Lines of communications will become long and erratic.
- Equipment and supply stockpiles will have to be smaller and more widely dispersed.
- Digital and communications equipment used for managing CSS functions will be vulnerable to EMP effects.
- Training of CSS personnel will need to include how to construct overhead cover and how to monitor, decontaminate, and coordinate obstacle clearance.

NOTE: See FM 3-3 and FM 3-3-1 for specific techniques.

### COMBAT SERVICE SUPPORT OPERATIONS

The destructiveness of nuclear weapons will place an extremely high value on CSS operations. Consequently, successful CSS operations must be effective and efficient. There are five characteristics of effective, efficient CSS operations: anticipation, integration, continuity, responsiveness, and improvisation.

#### Anticipation

Anticipation means developing versatile and mobile CSS capabilities that can accommodate events in a nuclear environment. Combat service support planners must consider the impact of nuclear-weapons use by either enemy or friendly forces.

Protective measures and procedures to mitigate nuclear-weapons effects must be a routine part of operations. Even though the other effects of a nuclear detonation may not affect CSS logistic units, EMP effects could destroy digital and communications equipment. Combat service support commanders must ensure their units are well-trained and know how to protect themselves and their equipment.

#### Integration

Tactical and operational success depends on fully integrated support. However, integrating CSS activities will be more difficult after nuclear-weapons use by either enemy or friendly forces because—

- The tempo of battle will increase.
- Response times may be shorter.
- Support requirements may be greater.
- There will be greater than normal losses of personnel and equipment.
- Distances will be greater because of the dispersion of the force.

### Continuity

Continuity of support is the lifeblood of combat operations. Forces on the battlefield require continuous CSS to sustain fighting strength and agility.

To maintain continuous operations in a nuclear environment, CSS units must avoid radiological contamination, increase their mobility with more transportation, and mitigate initial and residual radiation effects. Mitigation techniques include using—

- Unit dispersion consistent with operational requirements to increase nuclear survivability.
- Overhead shelter, shielding materials, nuclear-hardened materials and shelters, and protective covers to lessen initial and residual radiation effects.
- Nuclear, biological, and chemical reconnaissance assets.
- Adequate decontamination capabilities.

NOTE: Contaminated units must faithfully follow decontamination procedures to ensure the maximum effectiveness of available assets. See also FM 3-5 and FM 3-100.

### Responsiveness

The CSS system must rapidly react to crises. As a rule, CSS commanders and staffs tailor and adapt units to fit mission requirements, often on short notice. The CSS response requires units to reestablish an uninterrupted support system or redirect an entire operational effort as a result of enemy WMD use. Combat and combat support (CS) units that perform high-priority missions receive priority CSS support.

Critical supplies will be temporarily prestocked near points of anticipated consumption to aid ongoing operations. However, planners must emphasize the need to reduce excessive buildup of stocks in areas subject to nuclear attack. When possible, resupply operations should occur at night.

### Improvisation

Improvisation is the talent to make, invent, arrange, or fabricate what is needed out of what is at hand. Successful logistic operations adapt to

changing situations. Combat service support personnel must be able to react to emergencies, improvising if necessary to continue operations.

Improvisation methods and supply sources can help maintain CSS continuity when standard procedures fail. For example, planners and operators may have to improve a support system after it has been disrupted by an enemy nuclear detonation. How well they react to such a challenge will be key to the force's survival.

## COMBAT SERVICE SUPPORT FUNCTIONS

### Personnel Support

The systems of personnel readiness management, casualty management, replacement management, and personnel accounting and strength reporting meet Army personnel requirements from mobilization and deployment through redeployment and demobilization.

Personnel readiness managers prepare requisitions in advance of hostilities based on projected losses linked to the command's vulnerability analysis. The commander updates battlefield requirements and casualty reports during hostilities.

Casualty operations managers require increased support to be able to accurately report the large numbers of immediate casualties nuclear weapons will cause and the increased casualties that will occur from intermediate and long-term radiation effects. There will be extremely high losses of manpower and materiel; rapid replacement will be essential.

Replacement management provides replacement personnel (individuals, crews, and teams) based on existing and projected losses. The theater replacement system must be responsive to the Army service component commander's (ASCC) priorities in order to provide replacements for soldiers most severely disabled by nuclear effects.

To sustain the force, CSS planners must carefully coordinate with maneuver and fire support planners to locate, prestock, and stage supplies and equipment well forward. They must be prepared to relocate unused supplies and support, or if this is not



possible, destroy them (except medical supplies) to prevent their capture. It is vital to return critical equipment to units as rapidly as possible.

When the commander decentralizes tactical units, CSS units must also assume dispersed, decentralized, and possibly forward positions to increase their capability to support the force. However, this decentralization must be balanced with the ability to provide responsive, uninterrupted support to the force.

*Class VI, personal demand items*, are normally sold through the exchange system. Combat service support units issue only essential Class VI items along with Class I supplies in an active nuclear environment.

### Maintenance

Maximizing equipment availability is a necessity in supporting a force-projection army. The difference between success and failure may be in—

- Having sound maintenance practices in all units.
- Positioning maintenance capabilities forward.
- Ensuring that units well-understand priorities for recovery and repair.
- Having quickly accessible repair parts.
- Overcoming the absence of repair parts normally requisitioned from CONUS depots via digital communications.

The commander may restrict maintenance support to emergency or short-term repairs because of the high volume of vehicles a nuclear detonation would damage. When battle conditions permit, maintenance support teams (MST) can perform more thorough on-site maintenance. Decontamination teams must assist MSTs before repair. The MST's performance will be degraded and repair times may increase when performing maintenance on contaminated vehicles.

In the initial stages of nuclear conflict, maneuver elements must rely on organic maintenance capabilities. They will need to perform battle damage assessment and repair (BDAR). They must separate vehicles into categories such as light damage, moderate damage, or severe damage even though they might not have access to testing, measuring, and diagnostic equipment. The commander should grant

wide discretionary authority to repair, cannibalize, evacuate, or destroy unserviceable equipment.

Performing maintenance in a contaminated environment requires balancing several conflicting requirements. The prime objective will be to rapidly return equipment to the user in a mission-capable condition.

The commander issues guidance as to whether to repair or abandon damaged equipment or to recover and evacuate it to an uncontaminated area. He bases his guidance on—

- The tactical situation.
- How critical the equipment is.
- The type and extent of contamination.
- The time and resources available.

Maintenance units in contaminated areas use collective protection shelters and existing fixed facilities to provide as much protection as possible for critical personnel and work areas. As soon as the tactical situation permits, units decontaminate inoperable equipment before it is recovered or evacuated to the support maintenance unit. If units cannot determine the degree of contamination, they mark the materiel using appropriate NBC markers.

To operate in the same environment as combat elements, maintenance elements in the forward combat area use maintenance element vehicles whose mobility, protection, survivability, and communications are compatible with those of the supported force. Maintenance units are to salvage only critical items in short supply. Upon command approval, they might possibly need to salvage critical contaminated items in order to return major weapons systems to operation.

*Class IX, repair parts and components*, includes kits and assemblies and items required for maintenance support of all equipment. Units store and transport Class IX repair parts in specially designed transporters for ease of movement and to reduce exposure to contamination. Combat service support units issue contaminated Class IX items only during emergencies.

Supply units widely disperse repair parts in the corps rear area to reduce vulnerability to nuclear weapons. Units store critical items in repair parts vans to reduce contamination and to ease

decontamination. Combat service support units issue repair parts in containers to protect the parts from becoming contaminated in transit. They issue all uncontaminated items before issuing decontaminated items. They check repair parts, especially sensitive electronic parts, for damage before issue.

### Transportation

Soldiers, patients, equipment, and supplies must be moved rapidly and in sufficient quantities to support combat operations. Tactical actions require timely concentration of units and materiel and often demand short-notice movement of large forces and major shifts in direction of movement.

There are a large number of factors which hinder efficient operations in a nuclear environment (tree blowdown, supply route closings, contamination avoidance, EMP effects on vehicle ignition systems and aircraft electrical components and systems, and refugee movements). Therefore, all plans and operations must be flexible enough to allow successful execution in a nuclear environment. Transportation units will require greater flexibility in selecting routes, marshaling areas, convoy configurations, and, particularly, designating communications means.

Alternative route planning is essential. Movement control elements in a nuclear environment are an important link to effective transport operations.

*Class III, petroleum, oil, and lubricants (POL)*, includes petroleum fuels, hydraulic and insulating oils, chemical products, antifreeze compounds, compressed gases, and coal. These items are highly critical in a nuclear environment. Frequently conducting survivability movements increases consumption of petroleum products and delivery requirements. This need may require an increase in bulk-fuel storage capacity in the corps area and the addition of more petroleum companies. Storage tanks and storage bladders used for bulk petroleum are vulnerable to the effects of thermal and blast. Units must take special care to reduce or prevent contamination of tanks and bladders.

When situations allow, corps petroleum units may provide throughput support to the forward support battalion (FSB). The units can deliver supplies directly to tactical units and to forward arming and refueling points (FARPs) in emergen-

cies. Army and Air Force aviation units conduct emergency resupply of isolated units.

Combat service support units should disperse petroleum storage locations and activities to reduce vulnerability and to prevent catastrophic losses. They must protect back-up equipment to the same degree as primary equipment and regularly practice fire-fighting and other safety procedures.

Whether performing combat, CS, or CSS functions, all units require uninterrupted fueling to perform effectively. Commanders must ensure the protection of fuel-storage facilities because such are extremely vulnerable to blast and thermal effects.

Units making survivability moves or exploiting nuclear-weapons effects will consume more fuel than anticipated. This, coupled with the possible loss of large amounts of fuel, makes the CSS function key.

NOTE: See FM 3-4 for mitigation techniques.

### Combat Health Support (CHS)

Although combat health support on the nuclear battlefield follows the basic principles of field medicine, the independent, dispersed nature of combat complicates this effort. Nuclear-weapons use will cause delays in treatment and increases in mortality and morbidity. The principles in appropriate medical field manuals will still be valid but will need to be modified for specific situations.

Centralized command with decentralized execution characterizes medical operations. Medical organizations must establish CHS away from potential nuclear targets and anticipate extreme surges in patient workload from mass casualty situations.

Triage is the medical process of classifying patients into four priority groups in which patients receive medical treatment: immediate, minimal, delayed, and expectant. Triage ensures the maximum benefit to the largest number of patients. Medical personnel use different triage priorities for patients with radiation, conventional, or combined injuries. The consequences of radiation injury are potentially severe. Medical personnel use radiation dose information during the triage process if it is available. Also, commanders and leaders monitor their

soldiers' radiation levels and provide that information to medical personnel upon evacuation.

Commanders, leaders, and soldiers can help medical personnel as much as possible to ensure the best care possible for the mass casualties expected from nuclear-weapons use. They can identify radiation casualties, decontaminate and evacuate casualties, and perform self-aid, buddy-aid, and combat lifesaver (CLS) procedures.

Commanders should use medical advice and information to weigh the options of keeping soldiers with radiation injuries in the field or sending them to CHS facilities. As well as handling radiation injured patients, the nuclear medical science officer, a staff officer of the medical brigade, and a staff officer of the medical group help determine radiation exposure levels.

Dose rate information is valuable in determining who can return to duty. For example, soldiers who have transient, initial symptoms that are not life threatening or too disabling or who have minor injuries and low RES can return to duty. This maintains the force's capabilities while ensuring that soldiers only enter the medical system when necessary or when they become ineffective.

Medical units do not have special hardened protection from blast, thermal, or radiation effects. They also do not have an organic decontamination capability. Therefore, unit commanders must provide this support to preserve and extend medical capabilities.

Commanders cannot hold medical units in reserve. They must plan and continue operations even after medical support is lost, relying only on self-aid and buddy-aid. Therefore, commanders must ensure soldiers have proper training.

Mental health and/or combat stress control personnel help soldiers cope with the increased stress of operating in a nuclear environment. Preventive medicine (PVNTMED) personnel help commanders and quartermaster water production personnel evaluate the effects of nuclear contamination on drinking-water supplies. PVNTMED personnel determine if the water is safe for consumption and provide guidance on disposal of contaminated water.

Veterinary personnel inspect and evaluate the safety of food supplies. They also determine when it is safe to slaughter animals for consumption.

Combat health logistic personnel ensure that medical supplies are protected from contamination and are as free of contamination as possible before issue to user units.

*Class VIII, medical material*, includes medicine, stretchers, surgical instruments, and soon. Resistant coatings, packaging material, or protective coverings protect medical supplies and equipment from radiological contamination. Combat health support personnel pre-position selected critical supply items and provide them on a preplanned resupply basis.

Medical personnel issue all uncontaminated medical supplies and equipment first. They issue contaminated items to a medical facility only after decontamination. They disperse stocks of medical supplies to prevent or reduce the damage or contamination nuclear weapons cause.

## Field Services

Field service support (FSS) consists of food preparation and water purification, laundry and shower services and clothing exchange and repair; mortuary operations; and airdrop services. Combat service support units in a nuclear environment provide FSS according to existing doctrine, with minor changes. In a nuclear environment, FSS generally consists of only those services which directly affect health and sanitation as well as such critical services as airdrop and mortuary operations.

Changes in Army doctrine require more mobility, responsiveness, and flexibility in Army field feeding operations. The new Army Field Feeding System-Future (AFFS-F) improves Army field feeding operations; provides efficiency in labor, water, and fuel requests; and increases mobility.

Elements organic to the corps support command (COSCOM) and the division support command (DISCOM) provide water purification for the corps and divisions. The supply company (in direct support (DS)) provides water purification for nondivisional elements at the tactical and operational levels on an area basis. These DS capabilities are normally sufficient for providing the requisite water. However, a general support (GS) capability, in the form of quartermaster water purification detachments, may be necessary in a nuclear environment. Water demands will be high and the likelihood of contamination great.

Laundry and shower services and clothing exchange and repair units may not be available in an active nuclear environment. However, if units are available they will be as close to affected areas as possible. Unit NBC teams and medical specialists will conduct radiological monitoring of all personnel before they shower to detect and segregate contaminated personnel. Contaminated personnel follow the decontamination procedures in FM 3-5. The unit will also check clothing for contamination before it is laundered and monitor waste water for radiological contamination.

On a nuclear battlefield all units, when authorized, will perform hasty burials of contaminated remains at an interim site as close to the place of death as possible. They are to mark the entire site with the standard NATO NBC markers. Recovery and decontamination of remains occurs after hostilities end (earlier if the tactical situation, time, and other resources permit). Decontamination of remains is a last priority.

Airdrop requirements significantly increase in a nuclear environment. Airdrop expedites resupply and allows swift bypass of contaminated areas. Units and airlift assets must consider the following when planning air movements or airlifts in a nuclear environment:

- Protective NBC clothing degrades aircrew performance and increases mission time.
- Navigators may have to rely on their own vision if they lose air and ground navigational aids.
- Avoiding contaminated areas requires planning air corridors on alternate routes.
- Loss of available airfields, aviation maintenance facilities and/or stores, and refueling facilities will reduce aircraft available for CSS missions.
- Off-loading cargo and servicing aircraft under contaminated conditions will increase mission time.
- Contaminated aircraft, cargo, and personnel will require special handling procedures in uncontaminated locations. Ideally, only uncontaminated aircraft will support uncontaminated units.
- Air movement operations may require the use of alternate airfields and landing sites to avoid contamination.

## Supply

General supply support encompasses the provision of clothing, water, barrier material, and major end items in support of the force. These classes of supply include all the systems that support the soldier.

Combat service support units conduct supply operations according to current doctrine when the potential for nuclear-weapons use is not likely. As nuclear risk increases, supply stockage for non-essential items will dwindle. This improves mobility and lessens the division's vulnerability to nuclear attacks. In an active nuclear environment, CSS units will reduce stockage to a level sufficient for mission accomplishment. Units must reduce stockages by the most expedient means in order to enhance mobility and dispersion and to avoid contamination.

Combat service support units should issue the most critical supply items on an automatic basis using the position locator reference system (PLRS) or a similar system. Forward units ensure that full basic loads of supplies are on hand and protected against contamination so they can accomplish their missions until CSS can resupply them. (Commanders should consider emergency resupply by air.)

Combat service support units should disperse their stocks to avoid presenting lucrative targets and to minimize risks of destruction or contamination. They should always issue uncontaminated stocks first so they can decontaminate stocks without interrupting supply support. (Using containers with protective overwrap enhances decontamination.)

Combat service support units do not normally issue contaminated stocks. Units keep contaminated stocks segregated from clean stocks until they can be fully decontaminated. However, units may issue certain contaminated supplies in emergency situations when insufficient uncontaminated supplies are available, but only if the supplies will provide a decisive tactical advantage to the receiving unit.

If units must use contaminated supplies, CSS units should first issue such supplies to similarly contaminated units. Only under the most dire circumstances should commanders issue contaminated stocks to uncontaminated units. In such dire cases, the issuing and receiving commanders must jointly decide to use contaminated items, basing

their decision on the tactical situation, the criticality of the items, the type and extent of contamination, and the resources available for decontamination.

**Class I, subsistence items**, includes gratuitous issue health and welfare items. Upon issue, units should store rations under protective covering or in containers to prevent or reduce contamination. Combat service support units do not normally provide preplanned Class I resupply to units in or near radiologically contaminated areas. Combat service supply personnel replace contaminated stocks on a priority basis up to authorized levels.

**Class II, items of equipment other than principal items**, includes individual equipment, clothing, tents, tools, and administrative and housekeeping supplies. Selected Class II items, such as NBC defense equipment, receive priority of issue to selected units. Combat service support units give the highest priority support to—

- Units in contaminated areas.
  - Units that have recently departed contaminated areas.
  - Units in forward areas.
- Combat service support personnel—
- Pack protective clothing in consolidated packages to expedite shipment, reduce handling, and protect it from nuclear contamination.
  - Pre-position decontamination items at all DS unit supply locations for resupply of stock held at the unit level.
  - Issue preconfigured push packages to all units requiring decontamination supplies.

**Class IV, construction and barrier materials**, includes lumber, sand bags, barbed wire, and so on. In an active nuclear environment, the DISCOM and other units stock only high-demand, mission-essential, Class IV items in the division area. The corps provides all other Class IV support.

Combat service support provides selected high-usage Class IV items. They issue contaminated or partially decontaminated Class IV items only after they properly mark and identify them. The user completes decontamination, if required. Large-scale decontamination operations may require additional support.

**Class V, ammunition**, includes small-arms rounds, artillery rounds, hand grenades, explosives, mines, fuzes, detonators, missiles, and bombs. Combat service support units store ammunition at dispersed sites to minimize nuclear vulnerability and to complicate the enemy's target-acquisition efforts. Class V supplies are as mobile as circumstances permit.

Large-scale decontamination operations may require additional support. If the situation requires units to use contaminated stocks, CSS personnel affix standard NATO NBC markers to the items. After issue, the user completes decontamination procedures, if required.

Ammunition support elements at every echelon take appropriate defensive measures to minimize the effects of and exposure to nuclear hazards. Using protective covers lessens exposure.

**Class VII, major end items**, includes such things as vehicles, self-propelled artillery pieces, missile launchers, and major weapons systems. Heavy materiel supply companies maintain stockage of Class VII items and, with assistance, are responsible for decontamination and affixing standard NBC markers before issue. If at all possible, they must not abandon radiologically contaminated Class VII items.

**Class X, material required to support nonmilitary programs**, includes items such as agricultural and economic-development project supplies.

NOTE: See also FM 10-1.

**Miscellaneous items** do not fit into any of the other classes. Items include bulk water (as a field service item), classified maps, captured enemy materiel, salvage material, and so on. Water is the most important. Large quantities of water are likely to be required for decontamination operations. Personnel must not issue or use radiologically contaminated water.

Water from local sources, such as lakes, ponds, and water systems, can become contaminated. It is essential to test local water sources for contaminants before use. Frequent testing is required and continuous testing is recommended. If quartermaster units suspect a water source is contaminated, they mark it with appropriate NATO NBC contamination markers. Units must not use water until

quartermaster units test it; treat it, if necessary; and medical specialists determine that it is safe to use.

When water becomes contaminated and cannot be treated for drinking, quartermaster or unit personnel dispose of it in a way that will prevent secondary contamination. They also mark the area appropriately. Quartermaster units monitor all water treatment, storage, distribution, and associated equipment, such as pumps and filters, for possible contamination.

Large-scale purification of water from contaminated water sources to supply drinking water and other purposes is limited to units equipped with reverse-osmosis water purification units (ROWPU). A standard contamination-level system allows flexibility in purification operations. Units must only drink uncontaminated water but can use water decontaminated to an acceptable level of risk for external purposes.

## SUMMARY

The logistic process in a nuclear environment changes drastically from how it is normally conducted. Logistic commanders will have to inte-

grate protective measures and procedures into daily operations to ensure necessary functions are capable of continuing their missions. The five characteristics of logistic operations are anticipation, integration, continuity, responsiveness, and improvisation.

Sustaining soldiers and their equipment takes on additional meaning in a nuclear environment. Of all the PSS functions, chaplain activities will be one of the most critical. However, the most important sustaining function will be combat health support. Triage will be the most demanding. Injuries ranging from severe wounds, loss of limbs, burns to radiation sickness will clog the medical facilities.

Field service support will also be critical. Therefore, the morale and the quality of life of the individual soldier must be maintained at as high a level as possible. Relief from the tension of combat and the ravages of war rejuvenates a soldier's ability to continue to fight. To that end, general supply support provides clothing, protective equipment, water, barrier material, and major end items in support of the force.

The classes of supply are the various items consumed on the battlefield. In a nuclear environment the consumption of each class will be amplified.

# GLOSSARY

## ACRONYMS AND ABBREVIATIONS

### Acronyms

<b>A<sup>2</sup>C<sup>2</sup></b> Army airspace command and control	<b>CDD</b> collateral damage distance
<b>AAP</b> allied administrative publication	<b>CEP</b> circular-error probability
<b>ACA</b> airspace control authority	<b>cGy</b> centiGray
<b>ACC</b> air component commander	<b>CHS</b> combat health support
<b>AD</b> air defense	<b>CINC</b> commander in chief
<b>ADA</b> air defense artillery	<b>CJTf</b> commander, joint task force
<b>ADP</b> automated data processing	<b>CLS</b> combat lifesaver
<b>AFSCC</b> Air Force service component commander	<b>CMO</b> civil-military operations
<b>AFFS-F</b> Army Field Feeding System-Future	<b>COA</b> course of action
<b>AMD</b> air movement distance	<b>COMSEC</b> communications security
<b>AMedP</b> Army medical publication	<b>CONPLAN</b> concept plan
<b>AO</b> area of operations	<b>CONUS</b> Continental United States
<b>AOR</b> area of responsibility	<b>COSCOM</b> corps support command
<b>ARFOR</b> Army Force	<b>CP</b> command post
<b>ASCC</b> Army service component command	<b>CS</b> combat support
<b>ATO</b> air tasking order	<b>CSS</b> combat service support
<b>ATP</b> allied tactical publication	<b>CTOC</b> corps tactical operations center
<b>ATTN</b> attention	<b>DA</b> Department of the Army
<b>BCE</b> battlefield coordination element	<b>D<sup>3</sup>A</b> decide, detect, deliver, and assess
<b>BDA</b> battle damage assessment	<b>DF</b> Department of the Army form
<b>BDAR</b> battle damage assessment and repair	<b>DGZ</b> desired ground zero
<b>BNW</b> battlefield nuclear warfare	<b>DISCOM</b> division support command
<b>BOS</b> battlefield operating system	<b>DNA</b> Defense Nuclear Agency
<b>(C)</b> classified	<b>DOD</b> Department of Defense
<b>CAC</b> Combined Arms Center	<b>DP</b> decision point
<b>C<sup>2</sup></b> command and control	<b>DS</b> direct support
<b>C<sup>3</sup>I</b> command, control, communications, and intelligence	<b>DST</b> decision support template
<b>C<sup>4</sup>I</b> command, control, communications, computers, and intelligence	<b>DSWA</b> Defense Special Weapons Agency
<b>CCIR</b> commander's critical information requirements	<b>EAC</b> echelons above corps
	<b>ELSEC</b> electronic security
	<b>EM</b> effects manual
	<b>EMP</b> electromagnetic pulse
	<b>ESM</b> electronic warfare support measures
	<b>FARP</b> forward arming and refueling point

<b>FLOT</b> forward line of own troops	<b>LD</b> line of departure
<b>FM</b> field manual	<b>LOC</b> lines of communication
<b>FSB</b> forward support battalion	<b>LOS</b> line of sight
<b>FSCL</b> fire support coordination line	<b>LRSU</b> long-range surveillance unit
<b>FSCM</b> fire support coordination measures	<b>LSD</b> least separation distance
<b>FSCOORD</b> fire support coordinator	<b>MACOM</b> major Army command
<b>FSE</b> fire support element	<b>MARFOR</b> Marine forces
<b>G1</b> assistant chief of staff, personnel	<b>MBA</b> main battle area
<b>G2</b> assistant chief of staff, intelligence	<b>METT-T</b> mission, enemy, terrain (and weather), troops, and time available
<b>G3</b> assistant chief of staff, operations and plans	<b>MSD</b> minimum safe distance
<b>G4</b> assistant chief of staff, logistics	<b>MSF</b> mobile striking force
<b>G5</b> assistant chief of staff, civil-military operations	<b>MST</b> maintenance support team
<b>G6</b> assistant chief of staff, communications	<b>NALE</b> Navy amphibious liaison element
<b>GMD</b> ground movement distance	<b>NBC</b> nuclear, biological, and chemical
<b>GS</b> general support	<b>NBCC</b> nuclear, biological, and chemical center
<b>GSS</b> general supply support	<b>NCA</b> National Command Authorities
<b>HF</b> high frequency	<b>NEAT</b> nuclear employment augmentation team
<b>HOB</b> height of burst	<b>NIGA</b> neutron-induced gamma activity
<b>HPT</b> high-payoff target	<b>NSCC</b> Navy service component command
<b>HQ</b> headquarters	<b>OEG</b> operational exposure guide
<b>HVT</b> high-value target	<b>OPLAN</b> operation plan
<b>IPB</b> intelligence preparation of the battlefield	<b>OPORD</b> operation order
<b>J3</b> joint assistant chief of staff, operations and plans	<b>OPSEC</b> operations security
<b>JAOC</b> joint air operations center	<b>pam</b> pamphlet
<b>JCS</b> Joint Chiefs of Staff	<b>PLRS</b> position locator reference system
<b>JFACC</b> joint force air component command	<b>PNI</b> Presidential Nuclear Initiative
<b>JFLCC</b> joint force land component command	<b>PSS</b> personnel services support
<b>JFMCC</b> joint force maritime component command	<b>PSYOP</b> psychological operations
<b>JOPES</b> Joint Operations Planning and Execution System	<b>PVNTMED</b> preventive medicine
<b>JP</b> joint publication	<b>RAD</b> radiation dose
<b>JSCP</b> Joint Strategic Capabilities Plan	<b>REM</b> roentgen equivalent man (mammal)
<b>JTCB</b> joint targeting coordination board	<b>RES</b> radiation exposure state
<b>JTF</b> joint task force	<b>ROWPU</b> reverse-osmosis water purification unit
	<b>RSOP</b> resource and selection of positions



**SEAD** suppression of enemy air defense  
**SGEMP** system-generated electromagnetic pulse  
**SIGSEC** signal security  
**SO** signal operations/signal officer  
**SOCOORD** special operations coordinator  
**SOF** special operations force  
**SOLE** special operations liaison element  
**SOP** standing operating procedures  
**(SRD)** secret restricted data  
**STANAG** standardization agreement  
**STRATLAT** strategic liaison assistance team  
**STRIKWARN** strike warning  
  
**TM** technical manual  
**TNT** trinitrotoluene  
**TO** theater of operations  
**TPFDD** time-phased force and deployment data  
**TRADOC** US Army Training and Doctrine Command  
**TREE** transient radiation effects on electronics  
**(TS)** top secret  
**TTP** tactics, techniques, and procedures  
**TVA** target-value analysis  
  
**(U)** unclassified  
**US** United States  
**USANCA** United States Army Nuclear and Chemical Agency  
**USSTRATCOM** United States Strategic Command  
  
**vol** volume  
  
**WMD** weapons of mass destruction  
**WSRO** weapons system replacement operations

### Definitions

**Allocation (Nuclear):** (From JP 1-02.) The apportionment of specific numbers and types of nuclear weapons to a commander for a stated time period as a planning factor for use in the development of war plans. (Additional authority is

required for the actual deployment of allocated weapons to locations desired by the commander to support his war plans. Expenditures of these weapons are not authorized until released by proper authority.)

**Battlefield Nuclear Warfare (BNW):** (As used in this manual.) The requirement to conduct continuous combat operations in the environment created by the presence of any nuclear capable systems before, during, or after nuclear weapons employment.

**Combat Health Support (CHS):** Replaces Health Service Support.

**Coup de main:** (As used in this manual.) An offensive operation that capitalizes on surprise and simultaneous execution of supporting operations to achieve success in one swift stroke.

**Counterproliferation:** (As used in this manual.) Military measures centering both on how to deter or discourage, as well as attack and defend, against the possible use of weapons of mass destruction.

**Deconfliction:** (As used in this manual.) The procedure to prevent interference of one weapon's effects with another. The desired DGZs of nuclear weapons are separated in time or distance.

**Degree of Risk:** (From JP 1-02.) As specified by the commander, the risk to which friendly forces may be subjected to the effects of the detonation of a nuclear weapons used in the attack of a close-in enemy target; acceptable degrees of risk under differing tactical conditions are classified as emergency, moderate, and negligible. See also Emergency Risk (Nuclear); Moderate Risk (Nuclear); Negligible Risk (Nuclear).

NOTE: JP 3-12.2 (SRD) does not include moderate risk tables. The user can compute moderate risk by using JP 3-12.2.

**Emergency Risk (Nuclear):** (From JP 1-02.) A degree of risk where anticipated effects may cause some temporary shock and casualties and may significantly reduce the unit's combat efficiency. See also Degree of Risk; Moderate

Risk (Nuclear); Negligible Risk (Nuclear); and Troop Safety.

**Electromagnetic Pulse (EMP):** (From JP 1-02.)

The electromagnetic radiation from a nuclear explosion caused by Compton-recoil electrons and photoelectrons from photons scattered in the materials of the nuclear device or in a surrounding medium. The resulting electric and magnetic fields may couple with electrical/electronic systems to produce damaging current and voltage surges. It may also be caused by nonnuclear means.

**Executing Commander (Nuclear Weapons):**

(From JP 1-02.) A commander to whom nuclear weapons are released for delivery against specific targets or in accordance with approved plans. See also Releasing Commander (Nuclear Weapons). (For the purpose of this manual the executing commander is either the Air Force service component commander (AFSCC) or the Navy service component commander (NSCC).)

**Fallout:** (From JP 1-02.) The precipitation to earth of radioactive particulate matter from a nuclear cloud; also applied to the particulate matter itself.

**Fire Support Coordination Line (FSCL):** (From JP 1-02.) A line established by the appropriate ground commander to ensure coordination of fire not under the commander's control but which might affect current tactical operations. The FSCL is used to coordinate fires of air, ground, or sea weapons systems using any type ammunition against surface targets. The FSCL should follow well-defined terrain features. Establishing the FSCL must be coordinated with the appropriate tactical air commander and other supporting elements. Supporting elements may attack targets forward of the FSCL without prior coordination with the ground force commander provided the attack will not produce adverse surface effects on or to the rear of the line. Attacks against surface targets behind this line must be coordinated with the appropriate ground force commander.

**Minimum Safe Distance (MSD):** (As used in this manual.) The minimum distance in meters from the DGZ at which a specific degree of personnel risk and vulnerability will not be exceeded with a 99-percent assurance. The sum of the radius of safety and the buffer distance.

**Mitigation Techniques:** (As used in this manual.) Mitigation techniques are procedures to lessen the vulnerability of personnel and equipment to nuclear weapons effects. These techniques are intended to be field expedients that can be accomplished readily by individuals and units using only such equipment and material that are available on the battlefield.

**Moderate Risk (Nuclear):** (From JP 1-02.) A degree of risk where anticipated effects are tolerable or, at worst, a minor nuisance. NOTE: JP 3-12.3 does not include moderate risk.

**Negligible Risk (Nuclear):** (From JP 1-02.) A degree of risk where personnel are reasonably safe, with the exception of dazzle or temporary loss of night vision. (For this manual, negligible risk should not be exceeded unless significant tactical advantage will be gained. Expressed in terms of risk to unwarned exposed personnel and/or warned protected personnel.)

**Noncontiguous Battlefield:** (As used in this manual.) An area of operations subdivided by boundaries which delineate responsibility and facilitate control. The area of operations is non-linear; therefore, the intermingling of opposing forces is likely.

**Nonproliferation:** (As used in this manual.) Efforts focused on preventing the spread of missiles and weapons of mass destruction and arms control and export control.

**Nuclear Damage:** (From JP 1-02.)

1. **Light Damage:** Damage which does not prevent the immediate use of equipment or installations for which it was intended. Some repair by the user may be required to make full use of the equipment or installations.

2. **Moderate Damage:** Damage which prevents the use of equipment or installations until extensive repairs are made.

3. **Severe Damage:** Damage which prevents use of equipment or installations permanently.

**Nuclear Operations:** (As used in this manual.) See Battlefield Nuclear Warfare.

**Nuclear Weapon Option:** (As used in this manual.) A discrete grouping of a specific number of nuclear weapons by specific yield planned for employment in a specific area for a designated time for a specific purpose employed at corps level and higher.

**Nuclear Yield:** (From JP 1-02.) The energy released in the detonation of a nuclear weapon measured in kilotons or megatons of trinitrotoluene (TNT) required to produce the same energy release. Yields are categorized as—

**Very low:** less than one kiloton.

**Low:** 1 kiloton to 10 kilotons.

**Medium:** over 10 kilotons to 50 kilotons.

**High:** over 50 kilotons to 500 kilotons.

**Very high:** Over 500 kilotons.

**Operational Exposure Guide (OEG):** (As used in this manual.) The maximum amount of nuclear radiation which the commander considers his unit may be permitted to receive while performing a particular mission or missions.

**Radiation Dose Rate:** (From JP 1-02.) The radiation dose (dosage) absorbed per unit of time. A radiation dose rate can be set at some particular unit of time (for example, H + 1 hour) and would be called H + 1 radiation dose rate.

**System-Generated Electromagnetic Pulse (SGEMP):** (As used in this manual.) The gamma rays and, in some instances, x-rays from a nuclear burst that may interact with materials in systems and produce free electrons and electrical current that generate an electromagnetic pulse in the system itself.

**Strike Warning (STRIKWARN):** (As used in this manual.) Warning given in advance of a friendly nuclear attack to ensure that friendly forces are able to protect themselves from its effects. The nuclear, biological, and chemical center (NBCC) transmits the message to subordinate units likely to be affected by the attack. It also sends it to adjacent land, air, and naval

headquarters affected by the attack. The NBCC also sends the STRIKWARN to the next higher headquarters when units not under the control of the executing commander may be affected by the attack. STRIKWARNs are disseminated as rapidly as possible and, insofar as possible, over secure networks.

**Thermal Radiation:** (From JP 1-02)

1. The heat and light produced by a nuclear explosion.

2. Electromagnetic radiations emitted from a heat or light source as a consequence of its temperature; it consists essentially of ultraviolet, visible, and infrared radiations.

**Time on Target:** (From JP 1-02, as modified for this manual.) The time at which a nuclear detonation is planned at a specific DGZ.

**Transient Radiation Effects on Equipment (TREE):** (From TM 39-4-1, as modified for this manual.) The effect of initial radiation, neutron and gamma, on material. The effects can be either temporary or permanent. Semiconductors and other electronic components are especially sensitive to transient radiation effects.

**Troop Safety (Nuclear):** (From JP 1-02.) An element which defines a distance from the proposed burst locator beyond which personnel meeting the criteria described under degree of risk will be safe to the degree prescribed. (As used in this manual, it includes the commander's guidance and is divided into three degrees of risk: negligible, moderate, and emergency. Degree of risk is used to express personnel vulnerability as unwarned exposed personnel and warned protected personnel.

**Weapons of Mass Destruction:** (From JP 1-02.) In arms control usage, weapons that are capable of a high order of destruction and/or of being used to destroy large numbers of people. They can be nuclear, chemical, biological, and radiological weapons, but the means of transporting or propelling the weapons is excluded where such means are separable and divisible parts of the weapons.

**Weapons System Replacement Operations**

(WSRO): The integration of personnel, equipment, and training to maximize the number of operational weapons systems. Weapons systems managers coordinate with the operations staff, materiel managers, Class VII supply units, transportation managers, maintenance elements, and personnel managers to replace lost weapons systems.

NOTES:

1. See JP 1-02 for the complete definitions of the following terms:

- Collateral Damage Distance.
- Contamination.
- Decontamination.
- Desired Effects.
- Electronic Security (ELSEC).
- Flash Blindness.
- Heights of Burst (HOB).
- Immediate Permanent Ineffectiveness.
- Immediate Transient Ineffectiveness.
- induced Radiation.
- Initial Radiation.
- Latent Ineffectiveness.
- Least Separation Distance.
- Nuclear Air Burst.
- Nuclear, Biological, and Chemical Defense.
- Nuclear Bonus Effects.

- Nuclear Collateral Damage.
- Nuclear Damage Assessment.
- Nuclear Safety Line.
- Nuclear Surface Burst.
- Nuclear Underground Burst.
- Nuclear Vulnerability Assessment.
- Nuclear Warning Message.
- Nuclear Weapon.
- Overpressure.
- Planned Target (Nuclear).
- Proliferation (Nuclear Weapons).
- Radiation Dose.
- Radiation Exposure State.
- Radiation Sickness.
- Rainout.
- Releasing Commander.
- Residual Radiation.
- Unwarned Exposed.
- Warned Exposed.
- Warned Protected.
- Weapon Debris (Nuclear).

2. The following publications contain specific nuclear definitions that should be used in conjunction with this manual: JP 1-02, JP 3-12, JP 3-12.1, JP 3-12.2 (SRD), JP 3-12.3, DA Pam 50-3, and TM 39-4-1.

# REFERENCES

## REQUIRED PUBLICATIONS

Required publications are sources that users must read in order to understand or to comply with this publication.

### Department of the Army Pamphlets (DA Pam)

50-3 *The Effects of Nuclear Weapons.*

### Field Manuals (FM)

3-Series Includes all FM 3-series manuals.

3-3 *Chemical and Biological Contamination Avoidance.* This manual discusses in detail the four stages of contamination avoidance: implementation of passive defensive measures, oral reporting of attacks, location and identification of hazards, and limitation of exposure to hazards.

3-3-1 *Nuclear Contamination Avoidance.* This is the tactics, techniques, and procedures manual for nuclear contamination avoidance.

3-4 *NBC Protection.* This manual addresses unit and individual protection measures. See Chapter 4 for a detailed discussion of individual protection.

3-5 *NBC Decontamination.* This manual defines and clarifies the entire process of NBC decontamination. It shows how contaminated forces can survive, sustain, or restore their combat potential.

3-15 *Nuclear Accident and Incident Response and Assistance.* This manual contains guidance for training, equipping, and utilizing emergency teams for contamination control. It covers procedures and techniques for limiting radiation hazards.

3-100 *NBC Operations.* This manual provides leaders with the basic information they will need to help units survive and accomplish their missions on a nuclear battlefield.

6-20-10 *Tactics, Techniques, and Procedures for the Targeting Process.* This manual describes D<sup>3</sup>A targeting processes.

10-1 *Quartermaster Principles.*

12-6 *Personnel Doctrine.*

25-50 *Nuclear Survivability Training.*

63-3 *Corps Support Command.*

100-5 *Operations.* This is the Army's keystone operations manual.

100-7 *The Army in Theater Operations.*

100-9 *Reconstitution.*

100-10 *Combat Service Support.*

## FM 100-30

- 100-15 *Corps Operations*. This manual contains operational-level doctrine to corps commanders and staffs.
- 100-16 *Army Operational Support*.
- 100-17 *Mobilization, Deployment, Redeployment, Demobilization*.

### Joint Publications (JP)

- 1-02 *Department of Defense Dictionary of Military and Associated Terms*.
- 3-12 *Doctrine for Joint Nuclear Operations*. This publication sets forth doctrine for the combatant commander to use for the conduct of joint nuclear operations. It guides the joint planning and employment of US nuclear forces.
- 3-12.1 *Doctrine for Joint Nonstrategic Nuclear Weapons Employment*. This publication provides guidance for nuclear-weapons employment. Doctrine and guidance apply to the commander of combatant commands, subordinate unified commands, joint task forces, and subordinate components of these commands.
- 3-12.2 (SRD) *Nuclear Weapons Employment and Effects Data (U)*. This publication sets forth doctrine and selected TTP for joint operations and training. It is the accepted joint standard for nuclear target analysis, employment procedures, and the source for nuclear effects data.
- 3-12.3 *Nuclear Weapons Employment and Effects Data*.

### Department of Defense Nuclear Agency Effects Manuals (DNA EM)

- 1 (SRD) Chapter 10 Electromagnetic Pulse.
- Chapter 14 Effects of Personnel.
- Chapter 15 Damage to Structures.
- Chapter 17 Damage to Military Field Equipment.
- Chapter 21 Damage to Missiles.

NOTE: DNA is now known as the Defense Special Weapons Agency (DWA).

### RELATED PUBLICATIONS

Related publications are sources of additional information. They are not required in order to understand this publication.

### Allied Tactical Publications (ATP)

- 35A *Land Force Tactical Doctrine*. This publication establishes common NATO doctrine for the use of land force commanders in military operations when NATO forces are placed under their command.

- 45 *Reporting Nuclear Detonation, Biological and Chemical Attacks, and Predicting and Warning of Associated Hazards and Hazard Areas.* This publication contains procedures for reporting nuclear detonations, radioactive fallout, biological and chemical attacks, and for predicting associated hazards.

#### **Army Medical Publications (AMedP)**

- 6 *NATO Handbook on the Medical Aspects of NBC Defensive Operations.*  
 7 *Concept of Operations of Medical Support in an NBC Environment.*  
 8 *Planning Guide for the Estimation of Battle Casualties (Nuclear).*

#### **Field Manuals (FM)**

- 3-7 *NBC Handbook.* This manual provides information on the NBC warning and reporting system, contamination avoidance, and protection and decontamination.  
 5-103 *Survivability.* This manual integrates survivability into overall operations. It is for combined arms and engineer commanders.  
 8-9 *NATO Handbook on the Medical Aspects of NBC Defensive Operations.*  
 8-10-7 *Health Service Support in a Nuclear, Biological, and Chemical Environment.*

#### **Joint Publications (JP)**

- 5-03.1, Vol I *Joint Operations Planning and Execution System(JOPES).*  
 6, Vol II (SRD) *Standing Operating Procedures for the Coordination of Atomic Operations (U).*

#### **(TS) Joint Strategic Capabilities Plans**

- Annex C *Nuclear Operations.*

#### **Technical Manuals (TM)**

- 39-4-1 *Glossary of Nuclear Weapons Material and Related Terms.*

### **OTHER PUBLICATIONS**

#### **Allied Administrative Publications (AAP)**

*NATO Standardization Agreements and Allied Publications.* This publication lists STANAGs and other publications of interest to NATO.

#### **Department of the Army Forms (DF)**

- 2028 *Recommended Changes to Publications and Blank Forms.*

### Field Manuals (FM)

- 6-20 *Fire Support in Combined Arms Operations.* This is the keystone manual containing the principles of fire support.
- 34-1 *Intelligence Electronic Warfare Operations.*
- 34-40 *Electronic Warfare Operations.*
- 44-100 *Air Defense Operations.*
- 71-100 *Division Operations.* This manual describes how armored and mechanized divisions and brigades are organized and how they fight.
- 100-1 *The Army.* This manual covers the roles, principles, and precepts governing the employment of Army forces in support of national security objectives.

### SUGGESTED READINGS

Suggested readings are significant works for additional study and reflection.

#### Standardization Agreements (STANAG)

- 2002 Warning Signs for Marking of Contaminated or Dangerous Land Areas, Complete Equipment, Supplies, and Stores.
- 2047 Emergency Alarms of Hazard or Attack (NBC and Air Attack only).
- 2083 Commander's Guide on Radiation Exposure of Groups.
- 2103 Reporting Nuclear Detonations, Biological and Chemical Attacks, and Predicting and Warning of Associated Hazards and Hazard Areas. (*See also* ATP-45.)
- 2104 Friendly Nuclear Strike Warning.
- 2111 Target Analysis—Nuclear Weapons.
- 2112 NBC Reconnaissance.
- 2150 NATO Standards of Proficiency for NBC Defense.
- 2352 NBC Defense Equipment Operational Guidelines.
- 2353 Evaluation of NBC Defense Capabilities.
- 2358 First Aid and Hygiene Training in NBC Operations.
- 2367 NATO Glossary of NBC Terms and Definitions.
- 2435 NBC Protection Measures for Commodities Within Supply Channels.
- 2500 NATO Handbook on the Medical Aspects of NBC Defense Operations.
- 2874 Planning Guide for Estimation of Battle Casualties (Nuclear).
- 2910 Nuclear Casualties and Damage Assessment for Exercises.



# INDEX

## A

- Accuracy data, 3-8, 3-14.
- Acronyms, GI-1
- Acquisition
  - of WMD, 1-3,
  - strategy, 1-3.
  - systems, 3-1, 3-2.
- Active
  - defense. *See* Defense.
  - protection measures. *See* Protection.
- Aerial radiation survey. *See* Radiation.
- Agility, 5-1, 6-2.
- Aiming points, 3-17.
- Air
  - blast. *See* Blast.
  - burst. *See* Burst.
  - component commander (ACC), 3-7, GI-1.
  - corridors, 6-6.
  - defense (AD), iii, 3-8, 3-14, 3-17-3-19, 5-8.
  - defense artillery (ADA), 3-8.
    - See also* Suppression of enemy air defense (SEAD).
  - density, 2-1, 2-2, 5-4.
  - fields, loss of, 6-6.
  - Force, 1-4, 3-2, 3-8.
    - aviation units. *See* Units.
  - mobility, 5-7.
  - movement, 2-2, 6-6.
    - distance (AMD), 5-6, GI-1.
    - operations, 6-6.
    - operations center (AOC), 3-8.
    - tasking order (ATO), 3-9, GI-1.
- Aircraft, 3-8, 3-13, 5-6, 6-4, 6-6.
  - contamination. *See* Contamination.
- Airdrop
  - requirements, 6-6.
  - services, 6-5.
- Airhead, 3-4.
- Airlift, 6-6.
- Airspace
  - control authority (ACA), 3-8, 3-13, GI-1.
  - control measures, 3-13.
  - coordination, 3-13.
- Alert
  - posturing, 3-12.
  - status, 1-4.
- Allies/Alliances, 1-2, 1-3, 3-11, 3-12, 5-8.
- Allocation, GI-3.
- Ammunition (Class V). *See* Classes of supply.
- Anticipation, 6-1, 6-8.
- Approval, 3-9, 4-9, 6-3.
  - and issuance of OPLAN (OPORD), 3-2, 4-7.
  - by NCA. *See* National Command Authorities (NCA); Commander's approval.
  - command, 3-18, 6-4.
  - for targets, 3-6,
  - request for, 3-7.
- Area(s)
  - contamination. *See* Contamination.
  - defense, 5-5-5-9.
  - of employment, 3-1, 3-13, 3-16.
  - of interest, 4-5.
  - of operations, 3-10, 3-11, 3-16, 4-5, 5-1, 5-4, 5-9, GI-1.
  - of responsibility (AOR), 1-1, 3-10, GI-1.
- Arms
  - and export controls, 1-2, 1-3.
  - control agreements, 1-2, 1-3, 3-11.
- Army, 3-8, 3-16.
  - airspace command and control (A<sup>2</sup>C<sup>2</sup>), 3-8, GI-1.
  - aviation units. *See* Units.
  - commander. *See* Commanders.
  - Field Feeding System-Future (AFFS-F), 6-5, GI-1.
  - force (ARFOR), v, 3-3, 3-6, GI-1.
  - nuclear operations characteristics, 3-1.
  - operations. *See* Operations.
  - service component commander (ASCC), 3-19, 6-2, GI-1.
- Arrival times, 2-7.
- Assessment, 3-14, 3-15, 3-19.
  - See also* Decide, detect, deliver, and assess (D<sup>3</sup>A) targeting process; Threat assessment.
- Attack, 5-2, 5-3.
  - avenues, 5-5.
  - deliberate, 5-3.
  - frontal, 5-3.
  - hasty, 5-3.
- Audacity, 5-2,
- Automated data processing (ADP), loss of, 4-7, GI-1.
- Avenues of approach, 5-3.
- Aviation
  - maintenance. *See* Maintenance.
  - units. *See* Units.

## B

- Barrier material, 6-6, 6-7.
- Basic effects. *See* Effects.
- Battalion task force, 4-4.
- Battle,
  - command, 5-2.
  - damage assessment (BDA), 3-3, 3-6, 3-15, 3-17, 4-8, GI-1.

- damage assessment and repair (BDAR), 6-3, GI-1.
  - Battlefield, 3-13.
    - circulation, 3-18.
    - coordination element (BCE), 3-6-3-8, 3-10, 4-1, 4-8, 4-9, GI-1.
    - linear, 3-10,
    - noncontiguous, 3-10, 3-11, GI-4.
    - nuclear warfare (BNW), v, 4-1, 4-4, 4-7, 4-8, GI-1, GI-3.
    - operating systems (BOS), 3-17, GI-1.
    - planning, 3-15.
    - requirements, 6-2.
    - stress, 1-4.
  - Below-surface burst. *See* Burst.
  - Biological and chemical
    - attack, 1-2,
    - casualties. *See* Casualties.
  - Beachhead, 3-4.
  - Blackout, 2-3, 2-7.
  - Blast, 2-1, 3-15, 4-1, 5-6.
    - air, 2-1, 2-7.
    - effects, 2-1, 2-2, 2-5, 3-19, 6-4, 6-5.
    - initial, 2-8.
    - injuries, 2-8.
    - wave, 2-1, 2-6, 5-4.
  - Blowdown. *See* Tree blowdown.
  - Breaching. *See* Obstacles.
  - Bridging, 3-18.
  - Broadcast traffic, 4-3.
  - Buddy aid. 6-5.
  - Built-up areas. *See* Urban structures.
  - Burials,
    - hasty, 6-6.
    - marking of. *See* Nuclear, biological, and chemical (NBC) markers.
  - Burnout, 2-3.
  - Burns, 2-1, 2-8.
    - retinal, 2-2.
    - See also* Dazzle.
  - Burst, 2-2.
    - air, 1-3, 2-1, GI-6.
    - high-altitude, 2-3.
    - low-altitude (low air), 2-3, 2-8, 3-12, 3-14, 3-16, 5-4.
    - options. *See* Options.
    - space, 1-3.
    - subsurface (underground), 1-3, 2-1, 2-2, GI-6.
    - surface, 1-3, 2-1, 2-2, 3-12, 3-14, 4-2, GI-6.
  - Bypassing, 5-2.
- C**
- Campaign(s), 1-1, 3-3, 3-13.
    - area, 3-16.
    - coordination meeting, 3-9.
    - design, 5-3.
    - objective, 3-4,
    - plan/planning, 1-1, 3-1, 3-7, 3-8, 3-13, 3-14, 3-16, 4-2, 4-6, 4-8, 5-1.
  - Canalize, 5-1, 5-4, 5-8.
  - Casualty/Casualties, 1-4, 1-5, 2-8, 3-4, 3-8, 3-16, 3-18, 4-1, 4-3, 4-4, 4-7, 4-8, 5-1, 5-8, 6-2, 6-4, 6-5, 6-8.
    - management, 6-2.
    - reports, 6-2.
    - See also* Combat health support (CHS).
  - Chaplain activities, 6-8.
  - Circular-error probability (CEP), 5-9, GI-1.
  - Civilian
    - casualties. *See* Casualties.
    - preclusion criteria, 3-12.
    - protection. *See* Protection.
    - safety, 3-4, 5-6.
  - Civilian population, 4-2.
    - centers, 3-15, 3-16, 4-3.
    - location, 3-15, 3-16, 4-2, 4-5, 4-8.
    - overlays, 3-16, 4-3.
  - Civil-military operations (CMO), 4-4, GI-1.
  - Classes of supply, 6-3-6-8.
  - Close operations. *See* Operations.
  - Clothing, 6-7, 6-8.
    - exchange and repair, 6-5, 6-6.
  - Coalition, 3-11.
    - ad hoc, 3-11.
    - forces, 3-1, 3-11, 3-12.
  - Cold War, 1-2,
  - Collateral damage, 3-4, 3-10, 3-12, 4-3, 4-4, 4-6-4-8, 5-1, GI-6.
    - avoidance, 3-14.
    - constraints, 3-13.
    - criteria, 4-2, 4-3.
    - distance (CDD), 3-10, 3-11, 5-3, 5-6, GI-1, GI-6.
    - factors, 4-4, 4-5.
    - guidance, 3-16.
    - overlays, 3-17, 4-3, 4-5, 4-8.
    - preclusion, 3-19, 5-9.
      - criteria, 3-12, 3-16, 3-17.
      - data, 3-4.
    - prevention, 3-16.
    - See also* Damage preclusion criteria.
  - Combatant
    - command(ers), 3-3, 3-5, 3-11, 3-13.
    - command staff, 3-3.
  - Combat
    - effectiveness, 3-19.
    - elements, 6-3.
    - environment, 2-1.
    - functions, 6-1-6-4.

- health support (CHS), 2-5, 4-3, 4-4, 4-8, 6-1, 6-4, 6-5, 6-8, GI-1, GI-3.
- lifesaver (CLS) procedures, 6-5, GI-1.
- operations, 3-4, 3-11, 5-1, 6-2, 6-4.
- power, 1-4, 2-7, 2-8, 3-7, 3-18, 4-5, 5-4, 5-5, 5-7.
- service support (CSS), 3-17, 3-18, 5-1, 6-1, 6-2, 6-4-6-7, GI-1.
  - operations characteristics, 6-1.
  - stress control, 6-5.
  - support (CS), 6-2, GI-1.
  - units. *See* Units.
- Command approval. *See* Approval.
- and control (C<sup>2</sup>), 1-3, 1-4, 2-5, 2-8, 3-17-3-19, 4-7, 4-8, 5-1, 5-4-5-6, 5-8, GI-1.
  - See also* Enemy C<sup>2</sup> facilities.
- control, communications, and intelligence (C<sup>3</sup>I), 1-3, 3-14, GI-1.
- control, communications, computers, and intelligence (C<sup>4</sup>I), 2-3, 3-5, GI-1.
- guidance. *See* Guidance.
- post (CP), 3-18, GI-1.
- supervision. *See* Supervision.
- surgeon. *See* Surgeon.
- See also* Army airspace command and control (A<sup>2</sup>C<sup>2</sup>).
- Command and staff
  - responsibilities and procedures, 4-1.
  - action process, 4-1, 4-9.
- Commander(s), 6-4, 6-5.
  - Army, 4-1, 4-6, 4-9.
  - in chief (CINC), 1-1, 3-1-3-4, 3-6, 3-7, 3-10-3-14, 3-19, 4-7, 4-9, 5-1, 5-8, GI-1.
  - joint task force (CJTF), 3-10, 3-11.
  - nominating, 3-17.
  - of the joint task force (CJTF), 3-5, GI-1.
  - operational-level, 4-7.
  - senior Army, 5-5.
  - tactical, 5-8.
  - unit, 5-1, 5-7.
- Commander's
  - approval, 4-7.
  - concept, 1-1, 3-8.
  - critical information requirements (CCIR), 1-3, GI-1.
  - decision, 4-5.
  - estimate. *See* Estimate.
  - guidance, 3-5, 3-7, 3-12, 3-16, 4-1-4-3.
    - See also* Guidance.
  - intent, 1-1, 3-8, 3-12, 3-18, 4-1, 4-2, 4-5, 4-6, 4-9, 5-1, 5-3, 5-7.
  - will, 5-2.
- Commands. *See* Subordinate commands.
- Communications, 3-5, 3-6, 3-8, 3-13, 3-15, 3-18, 4-2, 4-7, 6-1, 6-3, 6-4.
  - blackout. *See* Blackout.
  - digital, 5-1, 6-1, 6-2.
  - electronic, 1-4.
  - equipment, 2-3, 2-4, 4-2.
  - satellite relay, 2-3.
  - security (COMSEC), 2-6, GI-1.
    - See also* Equipment; Lines of communications (LOC).
- Concentration, 5-2, 6-4.
- Concept
  - of operations, 3-5, 3-8, 3-13, 3-18, 4-7, 4-8, 5-3.
  - plan (CONPLAN), 3-2-3-4, 4-1, GI-1.
- Confusion, 1-4.
- Constraints, 3-2, 3-5, 3-7, 3-16, 3-17, 4-1, 4-2, 4-6.
  - See also* Controls and constraints; Nuclear policy constraints.
- Construction and barrier materials (Class IV). *See* Classes of supply.
- Contamination, 2-3, 4-1, 4-7, 6-2-6-8, GI-6.
  - area, 2-5, 3-15, 3-17, 4-2, 5-3, 5-6, 6-6, 6-7.
  - avoidance, 2-3, 2-6, 6-3, 6-4, 6-6, 6-7.
  - handling of contaminated material, 6-6, 6-7.
  - of personnel. *See* Personnel.
  - of water supply, 6-5.
  - levels. *See* Radiation exposure states (RES).
  - radiological, 2-3, 6-2, 6-7.
  - secondary, 6-8.
  - use of contaminated supplies, 6-6, 6-7.
    - See also* Radiation.
- Continental United States (CONUS), 3-3, 6-3, GI-1.
- Contingency(ies), 4-3, 4-7, 5-8.
  - force, 3-10, 3-11.
  - operations, 3-3, 3-10, 3-14.
  - plans/planning 3-2, 3-12, 3-16, 5-5, 5-8.
  - regional, 3-5.
  - tactical, 4-2.
- Continuity, 6-1, 6-2, 6-8.
  - See also* Logistics operations.
- Continuous operations. *See* Operations.
- Control, 1-3, 1-5, 3-18, 5-1.
  - agreements, 3-10.
  - centralized, 1-4.
  - of nuclear weapons employment, 3-16.
    - See also* Controls and constraints.
- Controls and constraints, 3-1, 3-7, 3-10, 3-12, 3-17, 4-1, 4-4.
  - See also* Nuclear policy constraints.
- Conventional
  - fires, 3-12, 4-6.
  - forces, 3-1, 5-9.
  - operations, 3-14, 4-2, 5-3, 5-5.
  - plans. *See* Plans.
  - support, 3-8.
  - target. *See* Target(s).
  - threat, v, 1-3, 2-6.

- warfare, 3-17.
  - weapons employment, 3-11, 4-3.
  - See also* Combat power.
  - Convoy configuration, 6-4.
  - Coordination, 2-5, 3-8, 3-18, 3-19, 4-1, 4-8, 5-1, 5-3, 6-1.
    - airspace, 3-8.
    - lateral, 3-10.
    - management, 3-8.
    - meeting. *See* Campaign.
    - of fires, 3-10, 3-17.
    - vertical, 3-10.
  - Corps, 3-2, 3-4, 3-9.
    - commander, 1-1, 3-5, 3-8, 3-10, 3-14-3-16, 3-18, 4-7.
    - rear area. *See* Rear area.
    - support command (COSCOM), 6-5, G1-1.
    - tactical operations center (CTOC), 3-9, G1-1.
    - targeting officer. *See* Targeting officer.
  - Counterattack, 5-4-5-6, 5-8, 5-9.
    - See also* Enemy counterattack.
  - Counterforce
    - operations, 1-3,
    - targeting strategy, 3-13.
  - Countermeasures, 2-5.
  - Counterproliferation, 1-3, 1-5, G1-3.
    - initiative, 1-3.
    - targets, 3-15.
  - See also* Nonproliferation; Proliferation.
  - Counterstrike target considerations. 3-12.
  - Coup de main, 3-4, G1-1.
  - Course of action (COA), 1-3, 3-14, 4-5, 4-6, G1-1.
    - analysis, 4-3, 4-4.
    - comparison, 4-4, 4-5.
    - development, analysis, and decision, 4-1, 4-2, 4-9.
  - Cover and concealment, 2-12, 5-4, 6-1, 6-2.
  - Crater/Cratering, 2-1, 2-5, 2-7, 5-4.
  - Crisis
    - action planning (CAP) process, 3-3, 3-4.
    - situation, 3-3, 3-19.
- D**
- Damage, 3-1, 4-2, 4-3, G1-4.
    - assessment 3-12, 4-4, 4-6, 4-8, G1-6.
    - limitation measures, 3-12.
    - preclusion criteria, 3-16.
    - See also* Battle damage assessment; Collateral-damage distance.
  - Dazzle, 2-2.
    - See also* Burns; Flash blindness.
  - Decentralization, 6-3.
  - Deception, 2-5, 2-6, 5-4.
  - Decide, detect, deliver, and assess (D<sup>3</sup>A) targeting process, 3-13-3-15, 3-17, G1-1.
    - See also* Targeting process.
  - Decision, 4-5-4-7.
    - brief, 3-10.
    - making process, 3-3, 4-1, 4-9, 5-8.
    - points (DP), 3-12, 4-3, 4-4, 4-6, G1-1.
    - support template (DST), 4-4, G1-1.
  - Deconfliction, 3-7, 3-8, 3-10, 3-12-3-15, 5-6, G1-3.
    - of targets, 3-14.
  - Decontamination, 2-5, 4-7, 6-1, 6-4-6-7, G1-6
    - capabilities, 4-5, 6-2, 6-5.
    - items, 6-7.
    - of equipment, 6-3.
    - of personnel, 6-6.
    - operations, 6-7.
    - procedures, 6-6.
    - teams, 6-3.
    - techniques, 1-5.
    - See also* Recovery.
  - Deep
    - attack, 5-1, 5-2.
    - attack cell, 3-9.
    - operations. *See* Operations.
    - targets. *See* Targets.
  - Defeat
    - criteria, 3-15, 4-4.
    - in detail, 2-5, 5-5.
    - mechanism, 3-15.
  - Defend and attack, 1-3.
  - Defense, 1-2, 1-3, 3-1, 5-5, 5-7, 5-9.
    - active, 1-3.
    - Nuclear Agency (DNA) Effects Manual (EM), 2-7, G1-1
    - passive, 1-3.
    - planning, 5-7, 5-8.
    - system, 1-2,
  - See also* Air defense; Air defense artillery; Mobile defense; Transition to the defense.
  - Defensive
    - operations, 3-16, 4-3, 5-1, 5-5, 5-7-5-9.
    - planning, 5-7.
    - positions, 5-6.
  - Definitions, G1-3.
  - Degree of risk, G1-3.
    - See* Risk.
  - Delay, disrupt, or destroy, 3-18, 5-1, 5-5, 5-8.
  - Deliberate-planning process, 3-2, 3-3.
  - Delivery, v, 3-1, 4-5, 5-4.
    - data, 3-8.
    - of weapons 3-14.
    - means, 3-8, 5-4.
    - of fires, 3-5.
    - platform, 3-13.
    - systems, 1-3, 1-5, 3-1, 3-8, 3-12, 3-17, 4-1, 5-1.

time, 5-6, 5-9.

Demobilization, 3-3, 3-5, 6-2.

Department of Defense (DOD), 1-3, G1-1.

Deployable defense system, 1-2.

Deploying forces, 1-5.

Deployment, 1-1, 3-3, 3-6, 6-2.  
of forces, 5-7.  
of nuclear weapons, 1-1, 1-4.  
plan, 3-6.  
*See also* Predeployment activities.

Depth, 5-1, 5-6, 5-7, 6-1.

Desired  
effects, G1-6.  
*See also* Effects.  
ground zero (DGZ), 3-8, 3-11, 3-16, 5-3, 5-6, G1-1.  
target effects, 3-16.

Deterrence, v, 1-2-1-5, 3-1, 3-11, 5-5, 5-8.

Detonation, 2-1, 2-2, 2-3, 2-7, 3-2, 3-18, 4-4, 6-1, 6-3.  
effects, 2-1.

Digital  
communications. *See* Communications.  
support, 4-5.

Direct support (DS), 6-5, 6-7, G1-1.

Discipline, 1-4,

Dispersal  
of equipment, 6-1, 6-4.  
of units, 1-4, 5-1, 5-2, 6-2.

Dispersion, 2-5, 5-4, 6-1-6-3, 6-6.  
*See also* Mass versus dispersion.

Distances, 5-6.

Division  
commander, 4-1.  
scheme of maneuver. *See* Scheme of maneuver.  
support command (DISCOM), 6-5, 6-7, G1-1.

Doctrinal  
guidance, 2-8.  
transition, 3-17.

Doctrine, v, vi, 1-3-1-5, 3-12, 3-13, 3-19, 5-4, 6-5, 6-6.  
employment, 1-4,

Dose  
rate, 3-19.  
rate information, 6-4, 6-5.

Dust. *See* Effects.

Dynamic pressure. *See* Blast wave.

Dynamics of combat power. *See* Combat power.

## E

Eardrum rupture, 2-1.

Early warning, 3-15.

Echelons  
above corps (EAC), v, 1-3, 3-5, 3-6, 5-6, G1-1.  
commander, 1-1,

below the CINC, 3-3.  
of command, 3-16.

Economy of force, 5-5.

Effects, 1-2-1-5, 2-1-2-3, 2-6, 2-7, 3-1, 3-2, 3-12, 4-1-4-3,  
4-5-4-8, 5-1-5-3, 5-8, 5-9, 6-1, 6-2, 6-4.  
basic, 2-1, 2-7, 2-8, 3-14, 5-6, 5-9.  
medical. *See* Medical effects.  
on terrain. *See* Terrain.  
reduction of, 5-2.  
*See also*. Arrival times; Blast effects; Desired effects;  
Electromagnetic pulse (EMP); Gamma rays; Mass  
effects; Mitigation techniques; Neutron(s); Protec-  
tion; Psychological and physiological stress; Radi-  
ation effects; Shielding; Thermal effects; Weapons  
effects; X-rays.

Electromagnetic pulse (EMP), 2-1, 2-3, 2-4, 2-7, 2-8, 3-18,  
3-19, 4-2, 4-5, 4-8, 5-1, 5-6, 6-1, 6-4, G1-1, G1-4.

Electronic  
communications. *See* Communications.  
security (ELSEC), 2-6, G1-1, G1-6.  
warfare support measures (ESM), 3-17, G1-1.

Emergency risk, G1-3.  
*See also* Risk.

Employment, 1-1, 3-1, 3-4, 3-12, 3-13, 4-4, 4-7.  
considerations, 2-1, 3-8.  
constraints. *See* Constraints; Control and constraints.  
coordination, 3-10.  
doctrine. *See* Doctrine  
of nuclear weapons, 1-1, 1-2, 3-5, 3-16.  
planning, 3-5, 3-17, 3-18.  
support, 3-6.  
taskings, 3-7.  
*See also* Nomination for employment; Timing.

Energy, 2-2.  
*See also* Reflected energy.

Enemy, 3-16, 5-4, 5-7.  
C<sup>2</sup> facility, 3-4.  
counterattack, 3-1, 3-4.  
employment methodology, 1-3.  
facilities, 5-3, 5-7.  
intent, 4-4.  
use of WMD, 1-1.

Engineers, 4-8.

Entry operations, 3-3, 3-4.  
*See also* Opposed entry operations; Unopposed entry  
operations.

Envelopment, 5-3, 5-9.

Environment. *See* Nuclear environment.

Environmental impact, 3-12, 4-8.

Equipment, 1-3, 3-11, 3-19, 6-1-6-4, 6-8.  
availability, 4-2, 6-3.  
backup, 6-4.  
destruction of, 2-8.

hardened, 2-6, 3-18.  
 readiness. *See* Readiness.  
 survivability, 2-6.  
*See also* Battle damage assessment and repair (BDAR);  
 Classes of supply; Communications; Mission-  
 essential equipment; Signatures; Supply.

Escalation, 1-2, 1-3,  
 "signal," 3-13.  
 Estimate(s), 4-2.  
     commander's, 4-5, 5-7.  
     of the situation, 4-3.  
 Evacuation, 6-3, 6-5.  
 Event templates, 4-2.  
 Executing commander, GI-4.  
     *See also* Commander(s).  
 Execution, 3-3, 3-6-3-8, 3-14, 4-8, 5-1, 5-3, 6-4.  
     decentralized, 6-4.  
     planning, 3-3, 3-8.  
     units, 3-6.  
 Exercises, 1-4.  
 Exploitation, 5-2-5-4, 5-8, 6-4.

**F**

Fallout, 2-3, 2-7, 2-8, 4-7, 5-4, GI-4.  
     hazards, 4-2.  
     militarily significant, 3-14.  
     prediction, 4-1, 4-2, 4-5, 4-7.  
     restrictions of, 3-12, 4-2.  
     *See also* Monitoring.  
 Feedback, 4-9.  
 Field  
     artillery, v.  
     feeding operations. *See* Army Field Feeding System-Future  
     (AFFS-F).  
     services, 6-1, 6-5.  
     services support (FSS), 6-5, 6-8.  
 Final delivery time. *See* Delivery time.  
 Fireball, 2-1, 2-3.  
 Firepower, 1-1, 2-7, 2-8, 3-17, 5-4.  
 Fire(s), 3-15, 5-1, 5-3, 5-4.  
     control  
         instruments, 2-8.  
         systems, 3-15.  
     forest, 2-1, 5-7.  
     interlocking, 5-6.  
     organization of, 5-5.  
     planning, 3-15, 5-2.  
     *See also* Coordination of fires; Synchronization.  
 Fire-fighting, 6-4.  
 Firestorms, 2-7.  
 Fire support, 3-10, 3-17, 3-18, 4-5, 4-6.  
     activities, 3-5.

Army lack of organic nuclear, 3-2.  
 cell, 3-10.  
 coordination line (FSCL), 3-10, GI-2, GI-4.  
 coordination measures (FSCM), 3-5, GI-2.  
 coordinator (FSCOORD), 3-16, 4-1-4-3, 4-5-4-8, GI-2.  
 element (FSE), 3-9, 3-16, 4-5, GI-2.  
 officers, 3-15.  
 planning. *See* Planning.  
     reduced, 1-4.  
 First use, 1-3.  
 Fixing, 5-3, 5-9.  
 Flash blindness, 2-1, 2-2, 2-8, 5-6, GI-6.  
     *See also* Burns; Dazzle.  
 Flexibility, 5-4, 5-9, 6-4, 6-5.  
 Food  
     preparation, 6-5.  
     supplies. *See* Veterinary personnel.  
 Force(s), 1-2, 1-4, 3-5.  
     allied. *See* Allies.  
     coalition. *See* Coalition forces.  
     contingency. *See* Contingency force.  
     locations. *See* Deconfliction.  
     movement, 5-4.  
     multinational. *See* Multinational forces.  
     multipliers, 5-5.  
     projection, 3-3, 3-6, 3-19, 6-3.  
     protection, 4-1, 4-7, 4-9, 5-1, 5-2.  
         *See also* Nuclear-force protection; Protection.  
     reorganization. *See* Reorganization.  
     reserve, 5-3, 5-5, 5-8.  
     supported, 6-3.  
     *See also* Economy of force; Movement.  
 Forest fires. *See* Fires.  
 Forward  
     arming and refueling point (FARP), 6-4, GI-2.  
     combat area, 6-3, 6-7.  
     line of own troops (FLOT), 3-4, 3-15, 3-16, 5-5, 5-8, GI-2.  
     support battalion (FSB), 6-4, GI-2.  
 Fratricide, 3-12, 5-1.  
 Freedom of action, 5-2, 5-3, 5-9.  
 Friction, 3-16.  
 Frontal attack. *See* Attack.  
 Fuel storage/Fueling protection, 6-4.  
 Functional areas, 6-1.  
 Future operations, 3-12, 3-15, 4-1, 5-2, 5-7, 5-8.

**G**

G1 and staff, 4-1, 4-3, 4-4, 4-7, 4-8, GI-2.  
 G2 and staff, 3-3, 4-1-4-8, GI-2.  
 G3 and staff, 3-12, 4-1, 4-3-4-8, GI-2.  
 G4 and staff, 4-1, 4-3, 4-4, 4-7, 4-8, GI-2.  
 G5 and staff, 3-16, 4-1, 4-3, 4-4, 4-7, 4-8, GI-2.

G6 and staff, 4-2, 4-3, 4-5, 4-7, G1-2.  
 Gamma rays, 2-2, 2-3, 2-7.  
 General supply support (GSS), 6-6, 6-8.  
 General support (GS), 6-5, 6-6, G1-2.  
 Ground  
   forces, 5-8.  
   movement distance (GMD), 5-6, G1-2.  
   operations, 3-13.  
   plan, 5-6.  
   shock, 2-7.  
   zero. *See* Desired ground zero (DGZ).  
 Guidance, 3-5, 3-9, 3-11, 3-12, 3-19, 4-2, 4-8, 4-9.  
   commander's, 3-8.  
   *See also* Collateral-damage guidance; Commander's guidance; Targeting guidance; Theater guidance.

## H

Hardened equipment. *See* Equipment. *See also* Vulnerability.

## Health

  and sanitation services, 6-5.  
   and welfare items, 6-7.  
 Height of burst (HOB), 2-2, G1-2, G1-6.  
 High-payoff target (HPT), 3-1, 3-4, 3-9, 3-14, 3-15, 5-1, 5-3, 5-8, G1-2.  
 High-value targets (HVT), 3-14, 4-1, G1-2.

## I

Immediate nuclear support, 1-1.  
   *See also* Preplanned nuclear support.  
 Immediate permanent ineffectiveness, G1-6.  
 Immediate transient ineffectiveness, G1-6.  
 Improvisation, 6-1, 6-2, 6-8.  
   *See also* Logistics operations.  
 Individual  
   aiming points, 3-17.  
   protection. *See* Protection.  
   target, 3-12, 3-17.  
 Induced radiation, G1-6.  
 Infiltration, 2-4, 2-5, 5-3, 5-7, 5-9.  
 Information, 4-1.  
   analysis, 3-17, 4-5, 4-8.  
   collection, 3-17.  
   displays, 4-8.  
   sharing, 3-8.  
   security, 2-5.  
   *See also* Lateral troop-safety information.  
 Infrared. *See* Radiation; Wavelengths.  
 Initial  
   effects. *See* Effects.  
   radiation, G1-6.  
   *See also* Radiation.  
   thermal radiation. *See* Radiation.

*See also* Blast; Contamination; Radiation.  
 Initiative, 3-15, 5-1, 5-2, 5-5, 5-7.  
 Injuries. *See* Casualties.  
 Inspection of nuclear materials, 1-3, 1-6.  
 Integration, viii, 1-1, 3-14, 4-9, 6-1, 6-8.  
 Intelligence, 1-3, 2-5, 2-8, 3-1, 3-8, 3-17, 4-2, 4-7, 4-8.  
   assets, 3-14.  
   collection, 3-15, 3-17, 4-8.  
   plan, 3-15.  
   estimate, 3-15, 4-3.  
   officer, 3-11, 3-15, 3-17.  
   operations, 2-6, 3-17, 4-9.  
   overlays, 4-8.  
   preparation of the battlefield (IPB), 3-17, G1-2.  
   readiness. *See* Readiness.  
   sensors, 3-15.  
   systems, 2-5.  
 Items of equipment (Class II). *See* Classes of supply.  
 Intent. *See* Commander's intent.  
 Interdiction  
   of routes, 5-5.  
   of shipments, 1-3,  
   procedures, 3-8.  
 Isolation, 1-4,  
 Interference. *See* Communications.  
 Intent. *See* Commander's intent.

## J

J3, 3-12, G1-2.  
 Joint  
   air operations center (JAOC), 3-6, G1-2.  
   assessment group, 3-9.  
   environment, 3-1.  
   forces, 1-4, 3-6, 3-13, 3-19.  
   nuclear operations, 3-1, 3-12.  
   nuclear support, 3-5.  
   operations, 3-1, 3-13.  
   procedures, 3-10.  
   service nuclear planning coordination requirements, 4-7.  
   tactical force, 3-13.  
   task force, (JTF), v, 3-3, 3-5, 3-6, 3-19, 4-1, G1-2.  
   task force commander. *See* Commander, joint task force (CJTF).  
 Joint Chiefs of Staffs review, 3-2.  
 Joint force  
   air component command(er) (JFACC), 3-2, 3-3, 3-8-3-10, 3-13, G1-2.  
   commander, 1-1,  
   land component command(er) (JFLCC), v, 3-2-3-4, 3-6-3-10, 3-13, 3-14, 4-1, 5-5, G1-2.  
   nuclear-weapons nomination cycle, 3-10.  
   maritime component command(er) (JFMCC), v, 3-2, 3-3, 3-6, 3-8, 3-9, G1-2.

task organization, 3-5.

Joint nuclear

doctrine. *See* Doctrine.

resources, 3-1.

Joint Operations Planning and Execution System (JOPES)

3-2, 3-4, GI-2.

Joint Strategic Capabilities Plan (JSCP), 3-2, GI-2.

Joint Targeting Coordination Board (JTCB), 3-5, 3-14, GI-2.

**L**

Land forces, 3-8.

Latent ineffectiveness, 2-8, GI-6.

criteria, 3-31.

Lateral

coordination. *See* Coordination.

troop-safety information, 3-10.

Law-of-land-warfare, 4-4.

Laundry and shower services, 6-5, 6-6.

Lead time. *See* Time.

Leaders/Leadership, 1-4, 1-5, 2-7, 2-8, 5-1, 5-7, 6-4, 6-5.

Least separation distance (LSD), 5-3, 5-4, 5-6, GI-2, GI-6.

Level(s)

of command, 3-16.

of damage. *See* Damage.

of exposure. *See* Operational exposure guide (OEG).

of war, 1-1, 1-5,

*See also* Operational level of war; Strategic level of war; Tactical level of war.

Liaison officers (LO), 3-11.

*See also* Special operations liaison element (SOLE).

Limits/Restrictions, 3-12, 3-13, 4-3.

Linear battlefield. *See* Battlefield.

Line-of-sight (LOS) shielding. *See* Shielding.

Line(s)

of communications (LOC), 1-4, 1-7, 5-8, 6-1, GI-2.

of departure (LD), 5-6, GI-2.

Local protection. *See* Protection.

Locations, 3-8.

Lodgement, 3-4.

Logistics, 2-8, 5-2, 5-8, 6-1, 6-8.

considerations, 3-14, 4-4, 4-7.

data, 4-8.

operations, 6-2, 6-8.

personnel, 6-9.

process, 6-1, 6-8.

support, 3-5, 3-6, 5-5, 6-5.

systems, 2-5.

units, 6-1.

Long-range surveillance unit (LRSU), 3-15, GI-2.

Low air burst. *See* Burst.

**M**

Main

battle area (MBA), 5-5, 5-8, GI-2.

effort, 3-5, 3-18, 5-2, 5-7.

Maintenance, 6-1, 6-3.

aviation, 6-6.

elements, 6-3.

support teams (MST), 6-3, GI-2.

units. *See* Units.

Major end items (Class VII). *See* Classes of supply.

Maneuver, 1-1, 1-5, 2-7, 2-8, 3-4, 3-13-3-15, 3-17, 4-6, 5-1, 5-4, 5-5, 5-7, 5-8, 6-3.

control, 3-5.

enemy, 4-5, 4-6.

forces, 3-18, 5-1, 5-2, 5-4, 5-5.

forms of, 5-3, 5-9.

planners. *See* Plans/Planning.

scheme of. *See* Scheme of maneuver.

units, 3-15.

Man-made structures, 2-1, 2-6, 5-3.

Map(s). *See* Operations map(s).

Marine

components, 3-8.

force (MARFOR), 3-2, GI-2.

Marshaling areas, 6-4.

Mass,

attack, 3-1.

casualties. *See* Casualties.

effects, 3-8, 5-1, 5-2.

forces, 5-1.

versus dispersion, 2-5, 4-4.

versus dispersion dilemma, 2-5.

*See also* Combat power; Dispersion.

Massed

nuclear strikes, 1-3.

units, 1-3.

Material required to support nonmilitary programs (Class X).

*See* Classes of supply.

Materiel-acquisition process, 2-6.

Medical

brigade or group, 4-1, 4-3, 4-4, 4-7, 6-4.

effects, 4-8.

facilities, 6-8.

material (Class VIII). *See* Classes of supply.

operations. *See* Combat health support (CHS).

personnel, 6-4, 6-5.

requirements, 1-4.

science officer, 6-5.

specialist, 6-6.

staff officers, 6-5.

supplies, 6-3, 6-5.

support, 6-5.



- treatment, 1-3.
  - units. *See* Units.
  - See also* Preventive medicine (PVNTMED).
  - Mental health personnel, 6-5.
  - METT-T. *See* Mission, enemy, troops, terrain (and weather), and time available.
  - Militarily significant fallout. *See* Fallout.
  - Minimum safe distance (MSD), 3-4, 3-10, 3-11, 3-15, 5-3, 5-6, GI-2, GI-4.
  - Miscellaneous items. *See* Classes of supply.
  - Missiles, 1-2, 1-3, 3-8, 3-13, 3-18, 4-1.
    - See also* Weapons systems.
  - Mission, 1-5, 3-5, 3-16, 4-2, 4-5-4-7, 5-1, 5-3, 5-7, 5-8, 6-6, 6-8.
    - accomplishment, 3-4, 4-9, 6-1, 6-2, 6-6.
    - analysis, 3-15, 4-1, 4-2, 4-8, 4-9.
    - enemy, troops, terrain (and weather), and time available (METT-T), 3-16, 5-3, 5-5, 5-7, 5-9, GI-2.
    - essential equipment, 2-6.
    - essential training. *See* Training.
    - receipt, 3-8, 3-16, 4-9.
  - Mitigation, 2-6, 4-3, 4-4.
    - measures, 3-18, 4-2.
    - requirements, 2-8.
    - techniques, 1-4, 1-5, 2-3, 2-5, 2-6, 3-19, 5-2, 5-6, 5-7, 5-9, 6-1, 6-2, 6-4, GI-4.
  - Mobile
    - defense, 5-5-5-9.
    - land battle targets, 3-14, 3-15.
    - striking force (MSF), 5-5-5-7, GI-2.
    - targets, 5-8.
  - Mobility, 2-6, 5-6, 5-7, 6-2, 6-3, 6-5, 6-6.
    - and survivability, 3-17, 3-18.
    - See also* Flexibility.
  - Mobilization, 3-3, 6-2.
  - Moderate risk. *See* Risk.
  - Monitoring, 4-7-4-9, 6-1, 6-4, 6-5.
    - communications, 2-5.
    - movement of nuclear materials, 1-1.
    - radiological, 1-5, 6-5.
    - See also* Fallout.
  - Morale, 5-7, 6-8.
  - Mortuary operations, 4-3, 4-8, 6-5.
  - Movement, 3-15, 3-17, 5-6, 5-7, 6-4.
    - control elements, 6-4.
    - of equipment, 2-5.
    - to contact, 5-2, 5-3.
    - See also* Force movement; Unit movement, employment, and protection.
  - Multinational
    - command, 3-11.
    - forces, 3-13, 3-19.
    - operations, 3-1, 3-8, 3-11, 3-12.
  - Multiservice military forces, 3-13.
  - Munitions, 4-1.
- ## N
- NALE. *See* Navy amphibious liaison element (NALE).
  - National
    - Command Authorities (NCA), 1-1, 1-4, 3-1, 3-2, 3-4, 3-6-3-9, 3-11, 3-12, 3-16, 4-7, GI-2.
    - objectives, 3-5.
  - Navigational aids, loss of, 6-6.
  - Navy, v, 1-4, 3-2.
    - amphibious liaison element (NALE), 3-6, 3-8, 4-8, GI-2.
    - components, 3-8.
  - Near-real time. *See* Time.
  - Negligible risk. *See* Risk.
  - Neutron(s), 2-2, 2-3, 2-7.
    - induced gamma activity (NIGA), 2-8, 5-3, GI-2.
    - See also* Effects.
  - Nominating commander. *See* Commander.
  - Nomination, 3-7, 3-8, 3-14, 4-2, 5-1.
    - corps, 3-10.
    - cycle, 3-9.
    - denial, 3-1.
    - for employment, v, 3-7.
    - of nuclear targets, 1-1, 1-5, 3-2, 3-5, 3-7, 3-8, 4-1, 4-4, 4-6, 4-8, 4-9, 5-5, 5-9.
    - of nuclear weapons, 3-4, 3-14, 3-17, 3-18, 4-8, 5-5.
    - plans, 4-2.
    - probability, 5-3.
    - process, 3-3, 3-17, 4-1, 4-4, 4-9, 5-4.
    - See also* Options; Target nomination.
  - Noncombatant(s)
    - casualties. *See* Casualties.
    - demographic data and overlays, 4-7.
    - information displays, 4-8.
    - status, 4-2.
  - Noncontiguous battlefield. *See* Battlefield.
  - Nondivisional elements, 6-5.
  - Nonnuclear fires, 3-17.
  - Nonproliferation, 1-3, 1-5, GI-4.
  - North Atlantic Treaty Organization (NATO), 6-6, 6-7.
  - Nuclear
    - annex, 3-2.
    - appendix of the OPOD, 3-2, 3-3.
    - bonus effects, GI-6.
    - See also* Effects.
    - employment augmentation teams (NEAT), 3-5, 3-6, 3-16, 3-19, 4-1-4-3, 4-5, GI-2.
    - environment, v, 1-1, 1-4, 1-5, 2-1, 2-3, 3-19, 5-2, 5-3, 6-1, 6-3-6-6, 6-8.
    - operations, v, 1-1, 1-5, 3-8, 4-5, GI-5.
    - See also* Operations planning.
    - policy constraints, 3-2.

safety line, GI-6.  
 support, 1-1, 1-4, 3-2, 3-3, 3-16, 5-1.  
*See also* Immediate nuclear support; Preplanned nuclear support.  
 warfare, 3-17.  
 weapons, 1-2, 2-1, 3-16, 4-3.  
 Nuclear, biological, and chemical (NBC), GI-2.  
 capabilities, 3-14.  
 center (NBCC), 3-10, 4-2, 4-5, GI-2.  
 clothing, 6-6.  
 contamination. *See* Survivability.  
 defense, 1-1, 3-5, 3-11, 4-1, 4-3, 4-9, 6-7, GI-6.  
 elements, 4-8.  
 estimate, 4-3.  
 markers, 6-3, 6-6-6-8.  
 protection process, 1-1, 1-4, 2-7.  
*See also* Protection.  
 reconnaissance assets. *See* Reconnaissance.  
 reports, 4-8.  
 staff, 4-3, 4-7, 4-8.  
 teams, 6-6.  
 warning and reporting system, 4-3.  
 weapons, 3-1.

**O**

Objectives, 1-3, 1-4, 3-1, 3-5, 3-9, 3-13, 3-14, 3-16-3-18.  
 Obstacle(s), 2-1, 2-5, 2-8, 3-12, 5-1, 5-4, 5-7.  
 breaching of, 3-18.  
 clearance, 6-1.  
 creation, 3-15.  
 Offensive operations, 1-2, 3-4, 3-16, 4-3, 5-1-5-5, 5-9.  
 Offense, 5-3, 5-5, 5-9.  
*See also* Planning.  
 Operational  
 analysis, 4-4.  
 area, 6-1.  
 considerations, 4-3, 5-1, 5-2.  
 data, 3-8.  
 effectiveness, 2-5,  
 exposure guide (OEG), 2-2, 2-3, 2-5, 4-4, 4-8, GI-2, GI-5.  
 guidance, 3-14.  
 information, 4-3.  
 level, 1-2, 6-5.  
 commander, 3-15, 3-16, 3-18, 4-6, 5-8.  
 of war, v, 1-1, 3-1, 3-12-3-14, 3-16, 4-6.  
 commanders. *See* Commander.  
 objectives. *See* Objectives.  
 overlay, 3-10.  
 plans/planning, 2-7, 3-1, 3-13, 3-17, 4-3.  
 situation, 3-8.  
 targets, 3-14.  
 Operation(s), 3-2, 3-10, 3-18, 4-9, 5-1, 5-2, 6-4.

close, 5-1, 5-3, 5-8, 5-9.  
 concept of. *See* Concept of operations.  
 contingency. *See* Contingency operations.  
 continuous, 3-2, 6-2.  
 deep, 5-1-5-3, 5-8, 5-9.  
 defensive. *See* Defensive operations.  
 entry. *See* Entry operations.  
 estimate, 4-3.  
 future, 2-4.  
 map(s), 3-4, 3-10.  
 officer, 3-15, 3-16.  
 order (OPORD), 3-3, 3-4, 4-1, 4-7, 4-9, GI-2.  
 overlay, 5-6,  
 plan (OPLAN), 3-2-3-7, 3-12, 3-15, 4-1, 4-7, GI-2.  
 annex, 3-2, 3-3.  
 appendix, 3-15.  
 planning. *See* Planning.  
 post-conflict,  
 psychological. *See* Psychological operations (PSYOP).  
 rear, 5-1, 5-2, 5-8, 5-9.  
 reserve, 5-9.  
 security (OPSEC), 2-5, 5-4, GI-2.  
*See also* Combat service support (CSS); Nuclear operations; Tenets of Army operations.  
 Opposed entry operations, 3-3, 3-4.  
 Option(s), 3-3, 3-6, 3-7, 3-12, 3-16, 3-19, 4-2, 4-3, 4-6-4-9, GI-5.  
 area, 3-34.  
 burst, 1-3.  
 methodology, 5-5.  
 parameters, 3-17.  
 planning, 3-7, 3-16, 4-2, 4-8.  
 criteria, 4-2.  
 strategic, 3-1.  
*See also* Planning; Response options; Warfighting options.  
 Orders, 4-7, 4-9.  
 preparation, 3-6.  
*See also* Air tasking order (ATO); Operations order (OPORD).  
 Overlay. *See* Noncombatant demographic data and overlay; Operations overlay.  
 Overpressure, GI-6.

**P**

Passive  
 defense. *See* Defense.  
 protection measures. *See* Protection.  
 Penetration, 5-2, 5-3, 5-5, 5-8.  
 Personal demand items (Class VI). *See* Classes of supply.  
 Personnel, 6-1.  
 accounting and strength reporting, 6-2.  
 combat service support, 6-1, 6-2, 6-7.  
 combat stress control, 6-5.

- contaminated, 6-5.
- issues, 4-3, 4-4.
- mental health. *See* Mental health.
- operations, 4-8.
- readiness. *See* Readiness.
- readiness management, 6-2.
- replacement. *See* Reconstitution.
- safety, 3-14.
  - See also* Troop safety.
- services support (PSS), 6-8, GI-2.
- strengths, 4-1.
  - See also* Reconstitution; Replacements.
- Petroleum, oil, and lubricants (POL) (Class III). *See* Classes of supply.
- Phases, 1-3, 3-10.
- Physical security, 2-5.
- Planned target, GI-6.
  - See also* Target planning.
- Planners, 3-2, 3-3, 3-16, 6-2.
- Planning, 3-1, 3-3, 3-8, 3-12-3-14, 3-16, 3-17, 3-19, 4-2-4-6, 4-8, 4-9, 5-3, 5-7-5-9, 6-6.
  - See also* Campaign plan; Operations planning.
  - and execution cycle, 3-5, 3-19.
  - cycle, 3-8.
  - guidance, 3-2, 3-3, 3-16.
  - methodology, 3-5.
  - peacetime, 3-16.
  - process, 1-4, 3-13, 4-9.
  - route, 6-4.
  - staff, 3-6.
  - the defence, 5-7.
  - the offense, 5-7.
  - wartime, 3-16.
  - See also* Campaign plan; Concept plan (CONPLAN); Crisis-action planning process; Deliberate-planning process; Employment planning; Executive planning; Joint Operations Planning and Execution System (JOPES); Operations plan (OPLAN); Options planning; Option planning criteria; Reconstitution planning.
- Plan(s), 1-4, 1-5, 3-10, 4-2, 4-7, 4-9, 6-4.
  - contingency. *See* Contingency plans.
  - operational, 4-2.
  - synchronized, 5-8.
  - unified, 5-8.
  - See also* Campaign plan; Concept plan (CONPLAN); Deployment plan; Radiological monitoring and surveying plan; Reconnaissance, selection, and occupation of position (RSOP) plan; Support plans; Synchronization plan.
- Population
  - centers, 3-8, 4-1, 4-8.
  - characteristics, 3-16.
- Position locator reference system (PLRS), 6-6, GI-2.
- Positioning approval document, 3-2.
  - See also* Dispersion.
- Post-conflict operations, 3-3, 3-4.
- Post-strike
  - damage assessment. *See* Damage assessment.
  - target analysis. *See* Target analysis.
- Preclusion
  - damage avoidance, 3-14, 4-2.
  - data, 4-1, 4-3.
  - oriented nuclear target analysis, 3-7.
  - overlays, 3-16, 4-3.
  - requirements, 3-7.
- Predeployment activities, 3-3.
  - See also* Deployment.
- Preparedness, 1-4, 1-5, 2-1, 3-8, 5-4, 5-8.
- Preplanned
  - nuclear support, 1-1.
    - See also* Immediate nuclear support.
  - resupply, 6-6, 6-7.
- Presidential
  - approval and release, v, 1-1, 3-1, 3-7.
  - Nuclear Initiative (PNI), v, 1-2, GI-2.
- Preventive medicine (PVNTMED), 6-5, GI-2.
  - See also* Medical support.
- Pre-wartime contingency planning. *See* Contingency plan.
- Procedures. *See* Staff procedures.
- Proliferation, 1-3, 1-5, GI-6.
  - of nuclear weapons, 5-7.
  - of weapons of mass destruction (WMD), 1-2, 3-11.
    - See also* Counterproliferation; Nonproliferation.
- Protection, v, 1-3, 2-2, 2-6-2-8, 3-2, 3-11, 3-14, 5-3, 5-5, 5-7, 5-8, 6-2, 6-3.
  - force, 3-12, 4-1, 5-2.
  - individual, 2-5.
  - local, 2-1.
  - measures, 2-4, 3-15, 4-3, 4-8, 6-1, 6-3, 6-6-6-8.
  - of civilian population, 4-2, 5-3.
  - of medical facilities, 6-5.
  - of logistic facilities, 6-1.
  - planning, 4-5.
    - See also* Mitigation techniques; Protection; Shielding.
- Psychological and physiological
  - effects, 1-4, 2-8.
  - environment, 2-1.
  - impact, 1-4.
  - preparedness. *See* Preparedness.
  - stress, 1-4.
- Psychological operations (PSYOP), 4-2, 4-7, GI-2.
- Publications for reference. *See* Reference section.
- Pursuit, 5-2, 5-3.
- Push packages, 6-7.

Q

- Quality of life, 6-8.
- Quartermaster
  - personnel, 6-5, 6-7, 6-8.
  - water purification detachments. *See* Water.

R

- Radar blackout. *See* Blackout.
- Radiation, 2-8, 4-2, 4-3, 5-4.
  - aerial survey, 4-7.
  - dose, G1-6.
  - information, 6-4.
  - rate, G1-5.
  - effects, 1-4, 2-5, 2-6, 6-2, 6-5.
  - infrared, 2-1.
  - initial, 2-1-2-3, 2-6, 2-7, 3-15, 5-6.
  - levels, 6-4, 6-5.
  - residual ionizing, 2-1, 2-2, 2-6-2-8, 5-6.
  - sickness, 2-1, 6-8, G1-6.
  - status, 2-8, 4-8.
  - thermal, 2-1, 2-6, 2-8, 3-15, 3-19, 5-6.
  - ultraviolet, 2-1.
  - See also* Casualties; Effects; Radiological monitoring and surveying plan.
- Radiation exposure
  - control, 2-3.
  - levels, 2-3, 2-5, 6-5.
  - states (RES), 3-19, 4-1, 4-8, 5-4, 5-7, G1-2, G1-6.
- Radiological
  - contamination. *See* Contamination.
  - monitoring and surveying plan, 4-2.
- Raids, 3-4.
- Rainout, 2-2, 5-4, G1-6.
- Rapid response. *See* Response.
- Reaction time(s), 1-4, 1-8, 3-8.
- Readiness, 3-10, 4-5.
- Rear
  - area, 6-3.
  - operations. *See* Operations.
- Reconnaissance,
  - assets, 6-2.
  - selection, and occupation of position (RSOP) plan, 3-6.
  - See also* Route reconnaissance.
- Reconstitution/Regeneration, 2-6, 3-3, 3-5, 3-12, 3-18, 3-19, 4-1, 4-4, 4-5, 4-7, 4-8.
  - planning, 3-18, 4-4.
  - See also* Resupply and reconstitution.
- Recovery
  - and decontamination. *See* Decontamination.
  - and repair, 1-5, 6-3.
- Redeployment, 3-3, 3-5, 6-2.
- Redundancy, 2-6.

- References, References-1.
- Refinements, 3-16, 3-17.
  - to approved options, 3-16.
  - to wartime planning, 3-16.
- Reflected energy, 2-1, 2-2.
- Refueling facilities, 6-6.
- Regeneration. *See* Reconstitution.
- Regional
  - conflicts, 1-4,
  - crisis, 3-1.
  - instabilities, v, 1-2, 1-5.
  - threats, 1-3,
- Rehearsals, 3-8, 4-6.
- Reinforcing forces, 5-1.
- Release, 1-1, 3-1, 3-13.
  - rate of, 2-2.
  - See also* Presidential approval and release.
- Releasing commander, G1-6.
- Reorganization, 3-19.
- Repair parts and components (Class IX). *See* Classes of supply.
- Replacement(s), 3-18, 4-3, 6-2.
  - management, 6-2.
  - operations, 3-19.
  - system, 6-2.
- Reserve forces. *See* Forces.
- Residual ionizing radiation, G1-6.
  - See also* Radiation.
- Resources, apportionment and allocation of, 3-5, 6-6.
- Response
  - options, 1-2, 3-16.
  - rapid, 3-10.
- Responsiveness, 1-3, 1-4, 6-1, 6-2, 6-5, 6-8.
- Restraint; restrictions, 1-2, 3-13.
- Resupply and reconstitution, 4-1, 6-2, 6-5, 6-6, 6-7.
- Retaliation, 1-3.
- Retinal burns. *See* Burns.
- Reverse-osmosis water purification units (ROWPU), 6-8, G1-2.
- Risk, 1-2, 3-1, 4-2, 4-5, 5-8.
  - assessment, 4-4, 4-6.
  - criteria, 2-3.
  - moderate, G1-4.
  - negligible, 3-4, 3-15, 4-2, G1-4.
  - nuclear, 6-6.
  - reduction, 5-2, 5-5.
  - unacceptable, 2-5.
  - See also* Degree of risk; Troop safety.
- Route, 3-18, 5-5, 6-4, 6-6.
  - planning. *See* Planning.
  - reconnaissance, 3-8.
  - withdrawal, 5-3.

Rubble, 3-15, 5-4, 5-7.

## S

### Safety

- criteria, 4-3.
- data, 3-4.
- information, 3-10.
- procedures, 3-10, 6-4.
- See also* Civilian safety; Lateral troop-safety information; Troop safety.

Salvage, 6-3.

Scheme of maneuver, 3-12, 3-16, 3-18, 4-1, 4-2, 4-5.

Security, 3-4, 5-2.

- See also* Communications security (COMSEC); Electronic security (ELSEC); Information security; Operations security (OPSEC); Physical security; Signals security (SIGSEC).

Self aid, 6-5.

Shelter. *See* Shielding.

Shielding, 2-1-2-3, 2-6, 5-8, 6-2.

- See also* Protection.

Shock, 1-4, 5-4, 5-5.

### Signal(s)

- annex, 4-7.
- operations (SO), 2-3, 4-8, GI-3.
- officer, 2-3, 4-8, GI-3.
- security (SIGSEC) 2-5, 5-4, GI-3.
- support, 4-3.

Signatures, 2-5, 3-10.

Sister services, 3-2, 3-8, 3-13-3-15, 3-18, 4-5, 4-9.  
support, 3-1.

Situation, 4-5.

- assessment, 4-8.
- development, 5-4.
- estimate, 4-3.
- updates, 4-8.

Small units. *See* Units.

Space burst. *See* Burst; Options.

### Special operations

- coordination detachment (SOCOORD), 3-8, GI-3.
- liaison element (SOLE), 3-6, 3-8, GI-3.
- force(s) (SOF), 3-8, 3-15, GI-3.

Spoiling attack, 2-4.

Staff, 4-8, 4-9.

- analysis, 4-6.
- assistance, 3-5, 3-6.
- elements, 4-1.
- estimate, 4-4, 4-5.
- procedures, 4-1, 4-7.
- supervision, 4-8.

- See also* Fire support coordinator (FSCOORD); G1, G2, G3, G4, G5, and G6; Planning staff.

Staging areas, 5-1.

Standardization agreement (STANAG), 3-11, GI-3.

Standing operating procedures (SOP), 2-3, 4-1, 4-2, 4-6, GI-3.

Statement of the commander's intent. *See* Commander's intent.

Static overpressure. *See* Blast wave.

### Stockage

- contamination and decontamination of, 6-6, 6-7.
- levels, 6-6.
- of supplies. *See* Classes of supply.
- reduction, 6-6.

Stockpile-to-target sequence, 5-4.

### Strategic

- considerations, v, 5-2.
- level
  - commander, 3-16.
  - of war, v, 1-1.
  - operations, 3-13.
  - planning, 3-1.
- liaison assistance team (STRATLAT), 3-5, 3-6, 3-19, GI-3.
- objectives, 3-3, 3-4.
- plan/planning, 3-1.
- theater, v, 1-1.

STRATCOM. *See* United States Strategic Command (US-STRATCOM).

Stress, 1-4.

Strike(s), 1-2, 1-3, 2-5, 3-1, 3-8, 3-10, 3-14, 5-1, 5-4, 5-6, 5-8.

force. *See* Mobile strike force (MSF).

warning (STRIKWARN), 3-6, 3-7, 3-12, 4-7, 4-8, GI-3, GI-5.

### Subordinate

- commander(s), 3-3, 3-5, 3-8, 3-13, 5-3.
- commands, 3-3.
- plans, 3-2.
- staff(s), 3-8.
- units. *See* units.

Subsistence items (Class I). *See* Classes of supply.

Supervision, 4-8.

Supply/Supplies, 6-1, 6-2, 6-6, 6-7.

- company, 6-5.
- critical, 6-3, 6-6.
- locations, 6-7.
- operations, 6-6.
- routes. *See* Routes.
- See also* General supply support (GSS); General support (GS).

Support, 6-1-6-3, 6-6, 6-7.

- characteristics, 6-1.
- functions, 5-1, 6-1.
- mission, 4-8.
- maintenance unit. *See* Units.
- mutual, 1-4.
- nuclear weapons employment, 3-5.

plans, 3-2, 3-13, 4-7.

reduced, 1-4,

requirements, 6-1, 6-2.

*See also* Conventional support; Electronic warfare support measures (ESM); Employment support; Fire support; Nuclear support.

Supportability, 2-5.

Supporting

commander, 3-7.

commands, 3-2.

forces, 5-2.

Suppression of enemy air defense (SEAD), 3-8, GI-3.

*See also* Air defense (AD); Air defense artillery (ADA); Defense.

Surface

areas, 3-13.

burst. *See* Burst.

conditions, 2-1.

ground, 2-1.

targets, 3-14.

Surgeon, 4-3, 4-4, 4-7, 4-8.

Surprise, 1-3, 3-4, 5-2, 5-4, 5-5, 5-7.

Survival/Survivability, vi, 1-4, 1-5, 2-4-2-7, 3-2, 3-17-3-19, 5-2, 5-7, 6-2, 6-3.

measures, 1-4.

movements, 6-4.

operations, 2-5, 3-18.

techniques, 1-4, 2-6, 2-7, 3-18, 3-19.

unit, 2-4, 2-5,

*See also* Contamination; Equipment survivability; Protection.

Sustaining the force, 5-2.

Sustainment, 5-9, 6-1, 6-8.

Synchronization, 3-12, 3-14, 3-16, 5-1, 5-5.

plan, 3-8.

System-generated electromagnetic pulse (SGEMP), GI-5.

## T

Tactical

considerations, 5-1, 5-2.

employment of forces, 3-13.

level, 1-2, 6-5.

commanders, 3-16.

of war, v, 1-1, 3-3, 3-14.

nuclear weapons, v.

objectives, 3-4.

offense, 5-3, 5-9.

operations center. *See* Corps tactical operations center (CTOC).

plan/planning, 3-1, 5-4.

units. *See* Units.

Tactics, techniques, and procedures (TTP), 2-5, 2-6, 5-4.

Targeting, 3-3, 5-4.

board, 3-9.

considerations, 3-14.

guidance, 3-2, 3-8.

nuclear, 3-13, 3-14,

officer, 3-15, 4-3, 4-5.

priorities, 3-14.

process, 3-13-3-15, 3-17.

Target(s), 3-1, 3-5-3-7, 3-10, 3-12, 4-6, 4-8, 5-1, 5-4, 5-5, 6-1.

acquisition, 5-2, 6-7.

analysis, 2-1, 3-1, 3-4, 3-9, 4-5, 4-6, 4-8.

nomination sequence, 3-7.

array, 3-15.

collection plan, 4-3.

conventional, 3-7.

critical, 1-3.

deconfliction of, 3-5, 3-10, 5-1.

deep, 2-8.

defeat criteria, 4-3.

engagement, 5-2.

evaluation, 3-7.

identifying, 3-13, 3-14.

lists, 3-5.

military, 3-13.

nomination, v, 1-1, 2-8, 3-2-3-8, 3-10, 3-14, 3-16, 3-17, 3-19, 4-2, 4-5, 4-9, 5-3, 5-6, 5-8, 5-9.

positioning of, 5-7.

priorities, 3-12, 3-14, 3-15.

selection, 3-11.

tracking, 3-15.

-value analysis (TVA), 3-15, 4-5, 4-6, GI-3.

vulnerability. *See* Vulnerability.

*See also* High-payoff target (HPT); High-value target (HVT); Planning.

Task organization, 3-5, 5-1.

Tempo, 1-1, 5-2, 5-5, 6-1.

Tenets of Army operations, 5-1, 5-9.

Terrain, 2-1-2-3, 3-14, 3-16, 3-18, 4-5, 4-8, 5-3, 5-5-5-8.

analysis of, 4-4.

shielding. *See* Shielding. *See also* Weather.

Terrorism, 1-2, 1-3.

Theater, 1-5.

CINC. *See* Commander-in-Chief.

guidance. *See* Guidance.

headquarters, 3-10.

level, 1-2, 3-13

movement of nuclear weapons within, 3-1.

nuclear weapons nomination sequence, 3-8, 3-9.

of operations (TO), v, 1-1, 3-1, 3-11, 3-13, GI-3.

of war, 3-13.

operations plan, 3-3.

*See also* Operations plan (OPLAN).

- strategic, v, 1-2.
  - intents, concepts, and objectives, 3-13,
  - objectives, 1-1, 3-4.
  - results, v.
  - See also* Campaign planning.
  - Thermal
    - absorption qualities, 2-1.
    - effects, 2-1, 2-2, 4-2, 6-4, 6-5
    - energy. *See* Energy.
    - radiation, GI-5.
    - See also* Effects; Radiation.
  - Threat, v, 1-2, 1-3, 1-5, 3-1.
    - arrays, 3-8.
    - assessment, 3-11, 4-2.
    - conventional, 2-6.
    - intelligence, 3-16.
    - operations, 1-3.
  - Time, 2-7, 6-6.
    - after detonation. *See* Arrival times.
    - and space, 4-5, 4-9, 5-1.
    - available, 5-4, 5-8.
    - employment, 3-6.
    - frame, 3-16.
    - lead, 3-15.
    - near-real, 5-2.
    - on target, GI-5.
  - phased force and deployment data (TPFDD), 3-2-3-4, 3-10, GI-3.
    - requirements, 3-14.
    - See also* Delivery time; Lead time.
  - Timing, 3-1, 3-8, 3-10, 3-13-3-15, 5-6.
  - Trade-off
    - analysis, 5-1.
    - matrix, 5-5, 5-6, 5-9.
  - Training, v, 1-4, 1-5, 2-1, 2-7, 3-11, 3-19, 5-7, 5-8, 6-1, 6-5.
  - Transient radiation effects on electronics (TREE), 2-3, 2-4, GI-3, GI-5.
  - Transition to the offense, 5-5.
  - Transportation, 6-1, 6-2, 6-4.
    - networks, 5-8.
    - operations, 6-4.
    - units. *See* Units.
  - Transition(s), 3-10.
    - to the defense, 5-7.
  - TREE. *See* Transient radiation effects on electronics (TREE).
  - Tree blowdown, 2-1, 3-15, 5-4, 5-7, 6-4.
  - Triage, 2-8, 4-8, 6-4.
  - Troop(s), 5-4, 5-7.
    - concentrations, 3-14.
    - safety, 3-4, 3-10, 3-12, 3-14, 3-17, 4-2, 4-4, 4-6, 4-7, 5-1, 5-3, 5-6, 5-7, 5-9, GI-5.
  - See also* Lateral troop-safety information; Safety.
  - Turning movement, 5-3.
- ## U
- Ultraviolet. *See* Radiation.
    - See also* Wavelengths.
  - Unconventional warfare, 5-7.
  - Underground facilities, 3-14.
  - Unified
    - command(s), 3-13.
    - commander, 3-11.
  - Unilateral initiatives, 1-1.
  - United States, GI-3.
    - Army Nuclear and Chemical Agency (USANCA), 3-5, 3-16, 3-19, 4-1-4-3, 4-5, GI-3.
    - Strategic Command (USSTRATCOM), 3-2-3-4, 3-6, 3-7, 3-19, GI-3.
  - Unit(s), 1-4, 5-8, 6-2, 6-3.
    - Air Force, 6-4.
    - Army, 6-4.
    - Aviation, 6-6.
    - adjacent, 4-9.
    - cohesion, 3-19.
    - combat service support, 6-1-6-7.
    - contaminated, 6-6, 6-7.
    - deployment plan, 3-10.
    - dispersion. *See* Dispersal of units.
    - field service support, 6-5, 6-6.
    - isolated, 5-1, 6-4.
    - locations, 3-8.
    - logistics, 6-1, 6-2.
    - maintenance, 6-3.
    - medical, 6-5.
    - movement, employment, and protection, 2-1.
    - preparation. *See* Preparedness.
    - quartermaster, 6-7, 6-8.
    - radiation exposure state (RES). *See* Radiation exposure state (RES).
    - replacement. *See* Replacement.
    - small, 1-4, 1-5, 5-8.
    - subordinate, 4-7, 4-9.
    - supply, 6-3.
    - support, 6-1.
    - supported, 3-10, 6-11.
    - survivability. *See* Survivability.
    - tactical, 6-3, 6-4.
    - transportation, 6-4.
    - uncontaminated, 6-6.
    - See also* Combat service support (CSS); Commanders; Massed units; Medical units; Reconnaissance, selection, and occupation of position (RSOP) plan; Reserve forces; Survivability.
  - Unopposed entry operations, 3-3.

Unwarned exposed, 3-4, 3-15, 4-2, G1-6.  
Urban structures, 2-1.

V

Vehicle(s), 6-4, 6-7.  
    maintenance unit, 6-3.  
    recovery and repair, 6-3.  
Vertical coordination. *See* Coordination.  
Versatility, 5-1.  
Veterinary personnel, 6-5.  
Visibility, 5-8.  
Vision, 6-6.  
    loss of, 2-2.  
    *See also* Dazzle; Retinal burns.  
Vulnerability, 2-4-2-6, 3-12, 3-17, 4-2-4-4, 4-6, 4-7, 5-1,  
    5-7, 5-9, 6-2-6-4, 6-6, 6-7.  
    analyses/assessment, 4-2, 4-3, 4-8, 6-2, G1-6.

W

Warfighting, 2-7  
    options, 1-2, 1-4,  
    tasks, 4-1.  
War  
    -gaming, 3-15, 4-4-4-6.  
    -termination, 3-3, 3-4.  
    -time planning, 3-16.  
Warned exposed, G1-6.  
Warned protected, 4-2, G1-6.  
    *See also* Risk.  
Warning system, 1-2.  
    *See also* Early warning.  
Warning  
    message, G1-6.  
    system, 1-2.  
    *See also* Early warning.  
Water, 6-5-6-8.  
    bulk, 6-7.  
    contamination. *See* Contamination.

production personnel, 6-5.  
purification, 6-5.  
treatment, 6-8.  
*See also* Reverse-osmosis water purification units (ROWPU).

Wavelengths, 2-1.  
Weapon(s), 3-8.  
    data, 3-8.  
    debris, G1-6.  
    effects, 2-1.  
    *See also* Effects.  
    enemy use of, 3-1.  
    environment, 1-3.  
    of mass destruction (WMD), v, 1-1-1-5, 3-1, 3-3, 3-4, 3-14,  
        4-1-4-4, 4-7, 5-7, 6-2, G1-3, G1-5.  
    *See also* Proliferation.  
    system replacement operations (WSRO), G1-6.  
    systems, 3-8, 3-15, 3-19, 5-8, 6-3, 6-7.  
    templates, 3-17.  
    types, 3-12.  
    yields. *See* Yields.  
    *See also* Counterproliferation; Delivery means; Effects;  
        Employment; Nomination; Nomination cycle; Non-  
        proliferation; Presidential approval and release; Pro-  
        liferation.  
Weather, 2-1, 3-16, 4-1, 4-4, 4-5, 5-4, 5-7, 5-8.  
    *See also* Terrain.  
Windows of opportunity, 5-8.  
Worldwide regional instability. *See* Regional instabilities.

X

X-rays, 2-2.

Y

Yield(s), 2-2, 2-3, 2-5, 3-1, 3-6, 3-12, 3-14-3-17, 4-1, 4-6,  
    5-1, 5-4, 5-9, G1-5.  
    limitation, 3-13.



FM 100-30  
29 OCTOBER 1996

By Order of the Secretary of the Army:

Official:

  
JOEL B. HUDSON  
*Administrative Assistant to the  
Secretary of the Army*  
02529

DENNIS J. REIMER  
*General, United States Army  
Chief of Staff*

DISTRIBUTION:

Active Army, Army National Guard, and U.S. Army Reserve: To be distributed in accordance with the initial distribution number 115477, requirements for FM 100-30.

**PIN: 074964-000**